

Energy Dispersive X-ray Fluorescence Spectrometer

EDX-7200





EDX-7200

Energy Dispersive X-ray Fluorescence Spectrometer

One EDX over all others

Principle and Features of X-ray Fluorescence Spectrometry

Principle of Fluorescent X-ray Generation

When a sample is irradiated with X-rays from an X-ray tube, the atoms in the sample generate unique X-rays that are emitted from the sample. Such X-rays are known as "fluorescent X-rays" and they have a unique wavelength and energy that is characteristic of each element that generates them. Consequently, qualitative analysis can be performed by investigating the wavelengths of the X-rays. As the fluorescent X-ray intensity is a function of the concentration, quantitative analysis is also possible by measuring the amount of X-rays at the wavelength specific to each element.

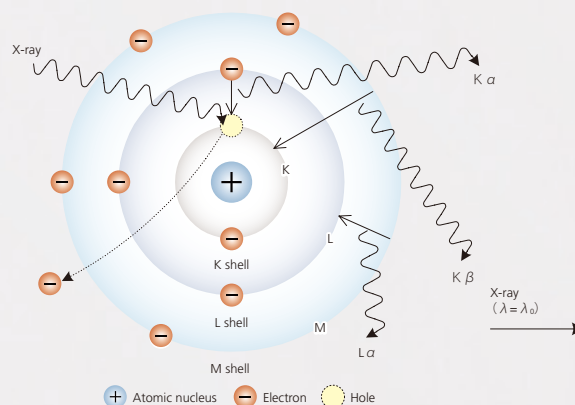

Electron Paths and Principle of X-ray Generation Expressed as a Bohr Model

Supports Various Applications in Many Fields

Electrical/electronic materials

- RoHS and halogen screening
- Thin-film analysis for semiconductors, discs, liquid crystals, and solar cells

Automobiles and machinery

- ELV hazardous element screening
- Composition analysis, plating thickness measurement, and chemical conversion coating film weight measurement for machine parts

Ferrous/non-ferrous metals

- Main component analysis and impurity analysis of raw materials, alloys, solder, and precious metals
- Composition analysis of slag

Mining

- Grade analysis for mineral processing

Ceramics

- Analysis of ceramics, cement, glass, bricks, and clay

Oil and petrochemicals

- Analysis of sulfur in oil
- Analysis of additive elements and mixed elements in lubricating oil

Chemicals

- Analysis of products and organic/inorganic raw materials
- Analysis of catalysts, pigments, paints, rubber, and plastics

Environment

- Analysis of soil, effluent, combustion ash, filters, and fine particulate matter

Pharmaceuticals

- Analysis of residual catalyst during synthesis
- Analysis of impurities and foreign matter in active pharmaceutical ingredients

Agriculture and foods

- Analysis of soil, fertilizer, and plants
- Analysis of raw ingredients, control of added elements, and analysis of foreign matter in foods

Other

- Composition analysis of archeological samples and precious stones, analysis of toxic heavy metals in toys and everyday goods



EDX-7200 Instrument Construction

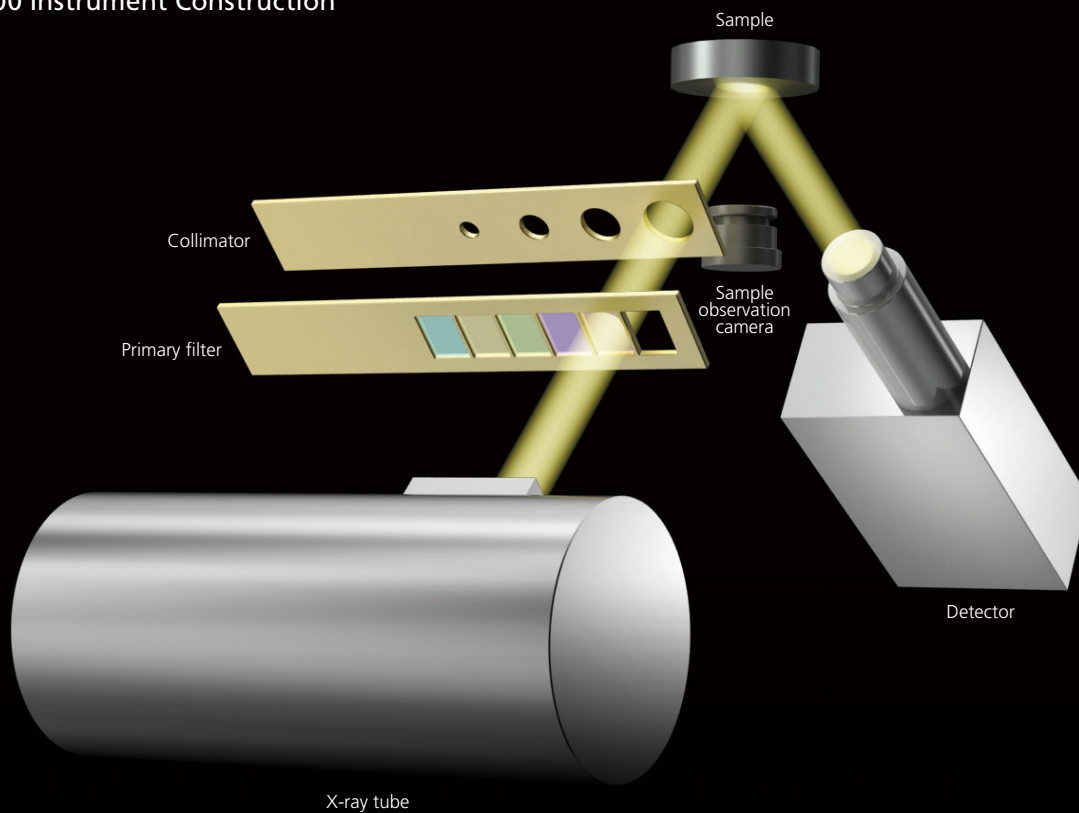



EDX-7200 for High Speed, High Sensitivity and High Accuracy

The EDX-7200 is equipped with a high-resolution SDD detector to achieve a higher count rate and detection efficiency.

High Speed – Throughput Increased by Up to a Factor of 30 –

Equipped with a high-speed circuit that increase the count rate by up to 30 times compared to the former model (EDX-720). Improved algorithms and improved performance also help to reduce measurement times.

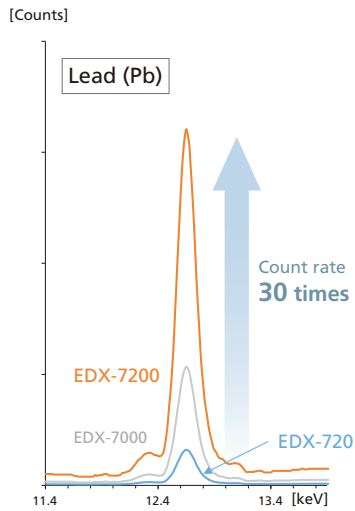

Comparison of Lead Profiles in Copper Alloys

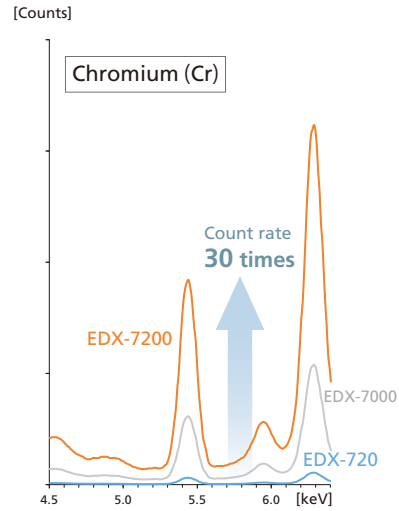

Comparison of Chromium Profiles in Copper Alloys

Comparison Using Actual Samples

Repeatability using the EDX-7200 and the previous model (EDX-720) was compared for lead (Pb) in lead-free solder.



Sample External Appearance

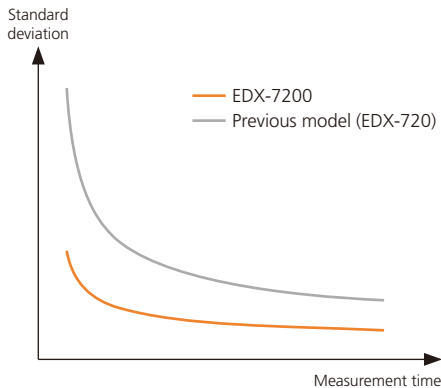

Relationship Between Measurement Time and Standard Deviation (Variance in Quantitation Values)

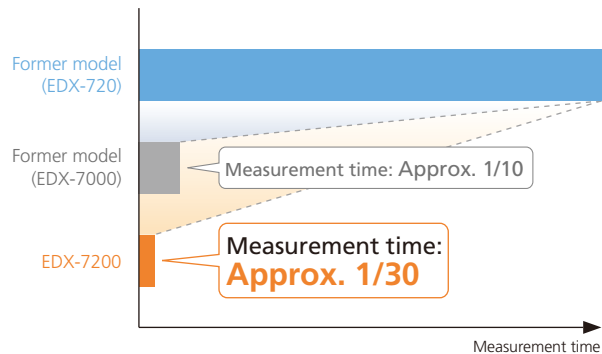

Measurement Time Required to Reach the Target Analysis Precision

Extending the measurement time to increase the fluorescent X-ray count can improve the precision (repeatability) of X-ray fluorescence spectrometry.

The EDX-7200 incorporates a high-count-rate SDD detector and a high-speed circuit that achieves highly precise analysis of the target in a shorter measurement time.

High Sensitivity – Improves Lower Detection Limit by Up to 6 Times –

In metals analysis, the lower detection limit of trace elements in main components has been improved.

Guide of the Lower Detection Limit (300 sec) for Lead in Metals

	EDX-7200	EDX-7000	EDX-720
Copper alloy	9.9	17.1	35.5
Solder	3.9	8.4	24.8
Aluminum alloy	0.7	1.1	3.3

Note: The detection limit is an example and not a guaranteed value.

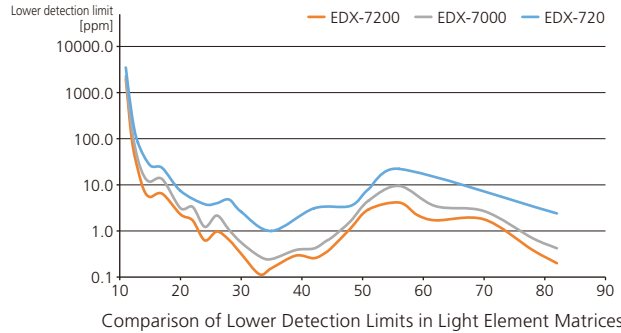

High Resolution

EDX-7200 offers superior energy resolution compared to previous models by incorporating a state-of-the-art SDD detector.

This reduces the effects of overlapping peaks of different elements, enhancing the reliability of the analysis results.

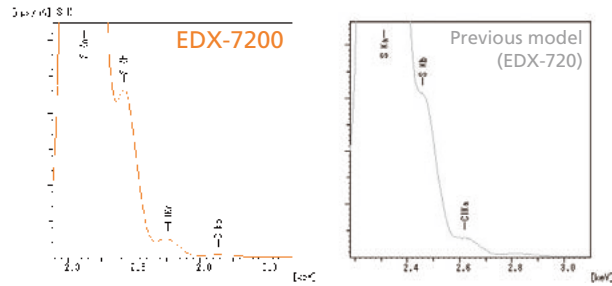

No Liquid Nitrogen Required

The SDD detector is capable of electronic cooling. Since there is no need to use liquid nitrogen, it reduces running costs.

Range of Detected Elements

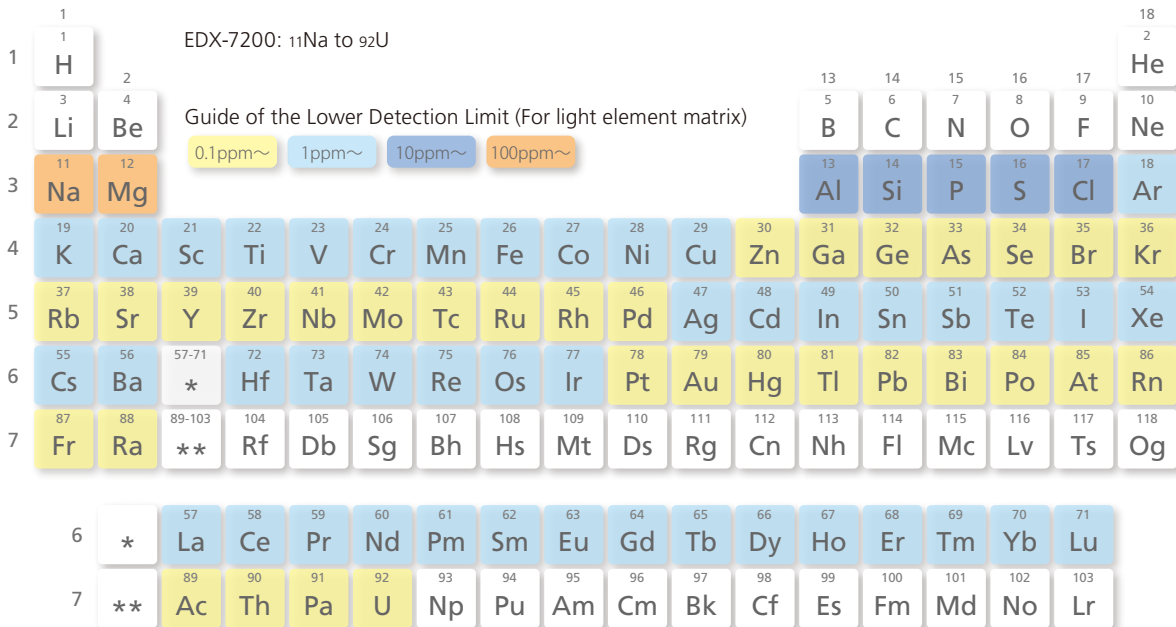

- An optional vacuum measurement unit or helium purge unit is required to measure light elements ($_{15}\text{P}$ and below) with the EDX-7200.
- Lower detection limit varies depending on the sample matrix or coexisting elements.
- Lower detection limit of light elements ($_{20}\text{Ca}$ and below) gets worse when the sample cell film is used.

Extremely Flexible

Accommodates all types of samples from small to large, from powders to liquids. Options include a vacuum measurement unit, helium purge unit for highly sensitive measurement of light elements, and a 12-sample turret for automated continuous measurements.

Sample Observation Camera and Collimators

Automatic collimator switching in four stages: 1, 3, 5, and 10 mm diameter

Select the irradiation chamber from four values to suit the sample size.

Select the most appropriate irradiation diameter for the sample shape: 1 mm diameter for trace foreign matter analysis or defect analysis; 3 mm or 5 mm diameter for small sample volumes.

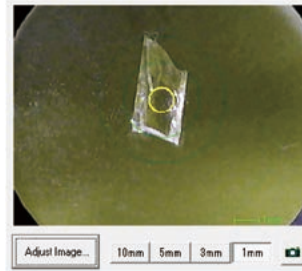

1 mm dia. Collimator Selected

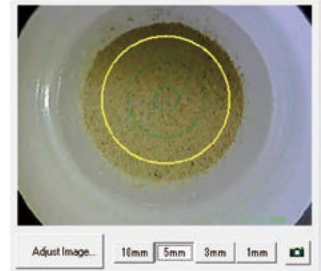

5 mm dia. Collimator Selected, Using Micro X-Cell

Sample observation camera included as standard

Use the sample observation camera to confirm the X-ray irradiation area on a specific position.

This is useful for measuring small samples, samples comprising multiple areas, or when using with a Micro X-Cell®.

New

Automatic Replacement of Five Primary Filters

Primary filters enhance detection sensitivity by reducing the continuous X-rays and the characteristic X-rays from the X-ray tube. They are useful for the analysis of trace elements.

The EDX-7200 incorporates five primary filters (six, including the open position), which can be automatically changed using the software.

Filter	Effective Energy (keV)	Target Elements (Examples)
#1	15 ~ 26	Mo, Rh, Pd, Ag, Cd, Sn, Sb
#2	2 ~ 4	S, Cl
#3	5 ~ 7	Cr, Mn, Fe, Co, Ni
#4	7 ~ 13	Zn, As, Br, Zr, Hg, Pb
#5	4 ~ 7	Ti, V

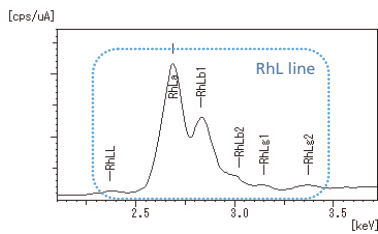

Filter. #2

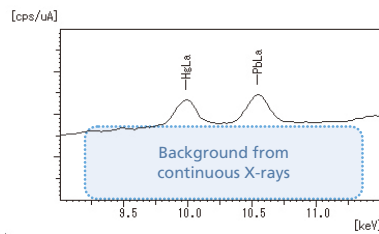

Filter. #4

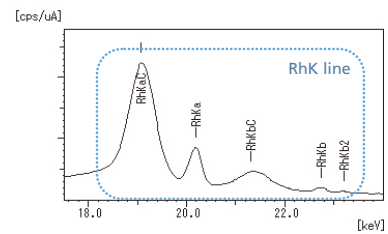

Filter. #1

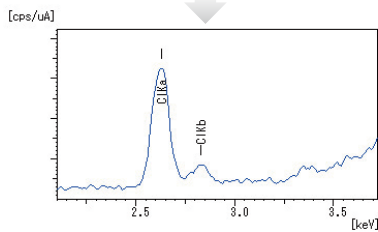

Sample : Cl-containing PE resin

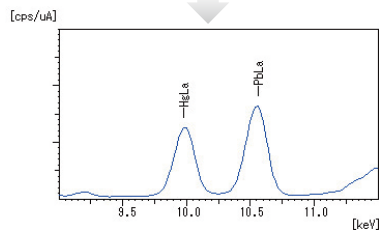

Sample : Hg/Pb-containing PE resin

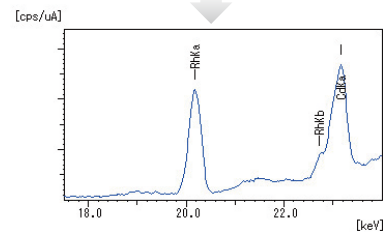

Sample : Rh/Cd-containing aqueous solution

Effect of the Primary Filters

Freely Combine Collimators and Primary Filters

The collimators and primary filters are driven independently and can be combined to address specific requirements. Select the optimal combination from 24 (6 filters x 4 collimators) available options.

Quantitative analysis using the FP method is possible with all combinations.

Vacuum Measurement Unit and Helium Purge Unit (Option)

Sensitivity for light elements can be increased by removing atmosphere. Two options are available: a vacuum measurement unit and a helium purge unit.

The helium purge unit is effective when measuring liquid samples and samples that generate a gas and cannot be measured in a vacuum.

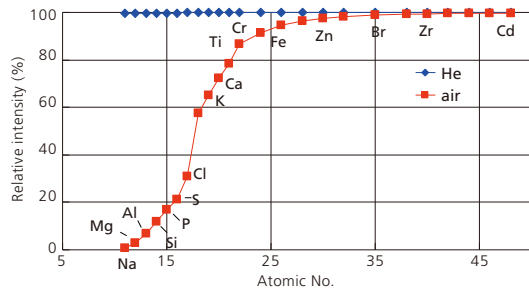

Relative Sensitivity of Measurements with Helium Purging and in Air (sensitivity in vacuum = 100)

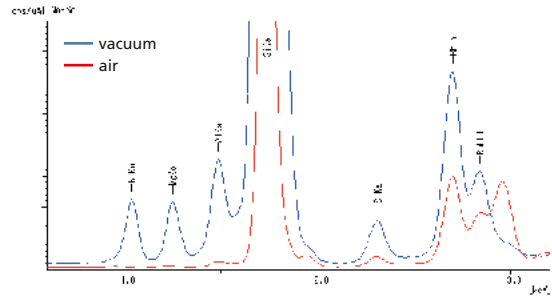

Profile Comparison in Vacuum and Air (sample: soda-lime glass)

Helium Replacement Measurement Unit (Option)

Helium replacement is effective for the analysis of the elements contained in a sample that cannot be placed in a vacuum atmosphere, such as generating liquid or gas. Equipped with a highly efficient helium gas replacement system (Japanese patent No. 5962855), it reduces measurement time and helium gas consumption.

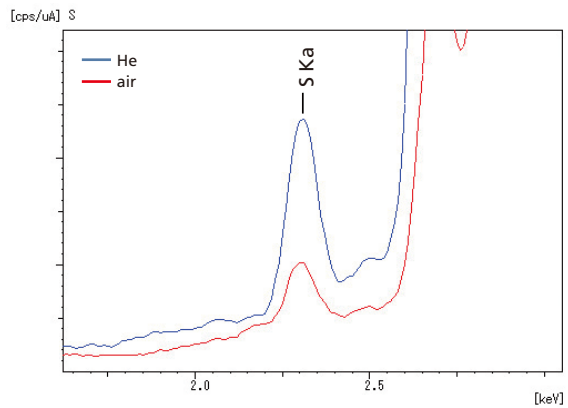

Profile Comparison in Air and Helium After Purging (EDX-7200 / sample: sulfur in oil)

12-Sample Turret (Option)

The addition of the turret allows automated continuous measurements. It improves throughput, especially for measurements in a vacuum or helium atmosphere.



With the turret guide removed, samples varying in size can be added.



Comprehensive Quantitation Functions

Calibration Curve Method

A standard sample is measured and the relationship with the fluorescent X-ray intensity plotted as a calibration curve, which is used for the quantitation of unknown samples. Although this method requires selection of a standard sample close to the unknown sample and creation of a calibration curve for each element, it achieves a high level of analysis accuracy.

This method supports all types of corrections for coexistent elements, including absorption/excitation correction and correction for overlapping elements.

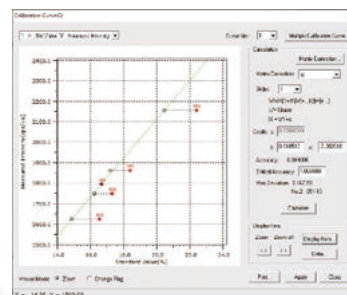

Fundamental Parameter (FP) Method

This method uses theoretical intensity calculations to determine the composition from the measured intensities. It's a powerful tool for the quantitative analysis of unknown samples in cases where preparation of a standard sample is difficult. (JP No. 03921872, DE No. 60042990. 3-08, GB No. 1054254, US No. 6314158)

Automatic Balance Setting Function (Patent pending)

A balance setting is required to use the FP method on principal components such as C, H, and O. The software automatically sets the balance if it determines from the profile shape that a balance setting is required.

Film FP Method

The instrument also offers the thin-film FP method function. The film FP method permits the film thickness measurement of multilayer films, simultaneous film thickness measurements, and quantitative film composition.

When using the film FP method, the substrate material, deposition sequence, and element information can be set.

Background FP Method

The background FP method adds scattered X-ray (background) calculations to the conventional FP method, which only calculates the fluorescent X-ray peak intensity (net peak intensity).

(Patent pending : Japanese Patent No. 5975181)

This method is effective at improving quantitation accuracy for small quantities of organic samples, film thickness measurements of irregular-shaped plated samples, and film thickness measurements of organic films.

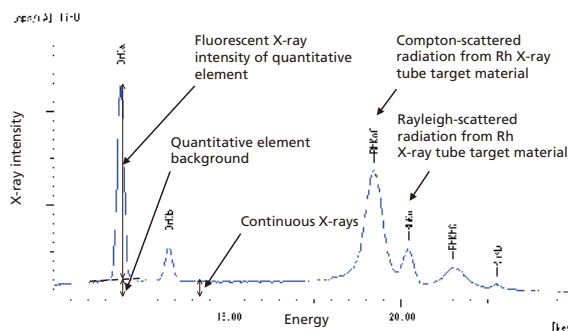

Matching Function

The matching function compares analysis data for a sample with an existing data library and displays the results in descending degree of confidence.

The library contains content data and intensity data and the user can register each type. The content data values can be entered manually.

Candidate	Diff. Factor
SUS_316	0.72200
SUS_316N	0.72200
SUS_316LN	1.10292
SUS_321	1.17556
SUS_305	1.18874
SUS_347	1.24270
SUS_316L	1.34046
SUS_304L	1.40968
SUS_304LN	1.49044
SUS_304N2	1.65853

Matching Results

Functional Design

Large Sample Chamber with Small Footprint

Installed width is 20% smaller than the previous instrument (EDX-720) due to its compact body size.
The EDX-7200 can accommodate samples up to a maximum size of W300 x D275 x approx. H100 mm.

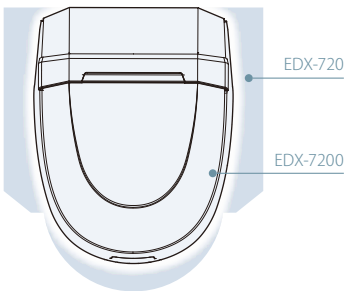

Body dimensions: W460 × D590 × H360mm
Comparison of footprint between
EDX-7200 and previous instrument

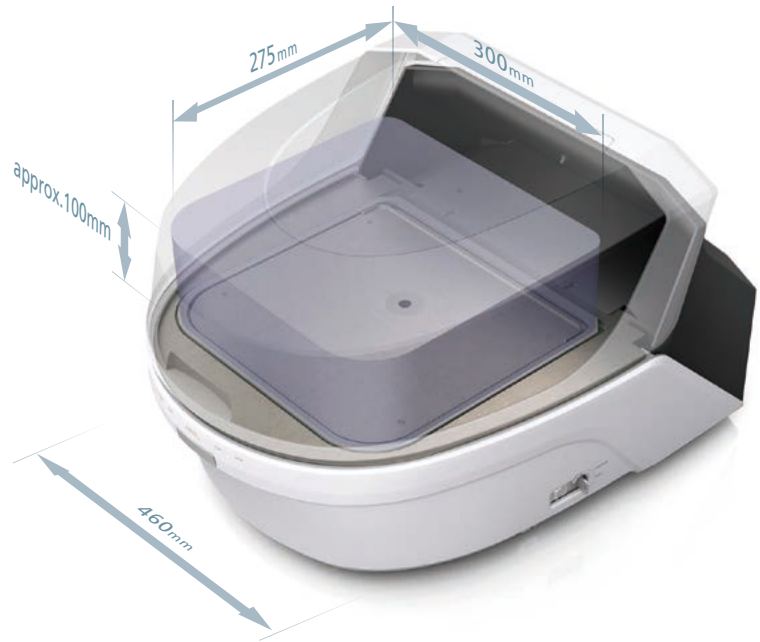

High-Visibility LED Lamp

When X-rays are generated, an X-ray indicator at the rear of the instrument and an X-RAYS ON lamp at the front turn on, so that the instrument status can be monitored even from a distance.



PCEDX Navi Software Allows Easy Operation from the Start

PCEDX Navi software is designed to simplify X-ray fluorescence spectrometry for beginners, while providing the feature set and capabilities demanded by more experienced users. The straightforward user interface offers intuitive operation and provides a convenient operating environment for beginners and experts alike.

Simple Screen Layout

Sample image display, analysis conditions selection, and sample name input on the same screen.

Collimator Switching from the Measurement Screen

Change the collimator diameter while observing the sample image. The selected diameter is indicated by a yellow circle.

Automatic Storage of Sample Images

The sample image is loaded automatically when the measurement starts. Sample images are saved with a link to the data file.

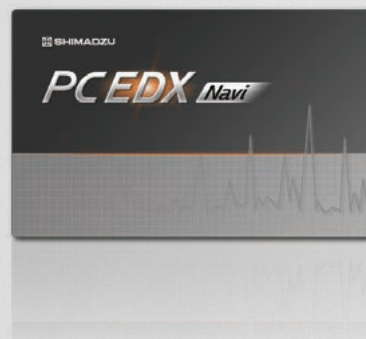

Measurement Setup Screen

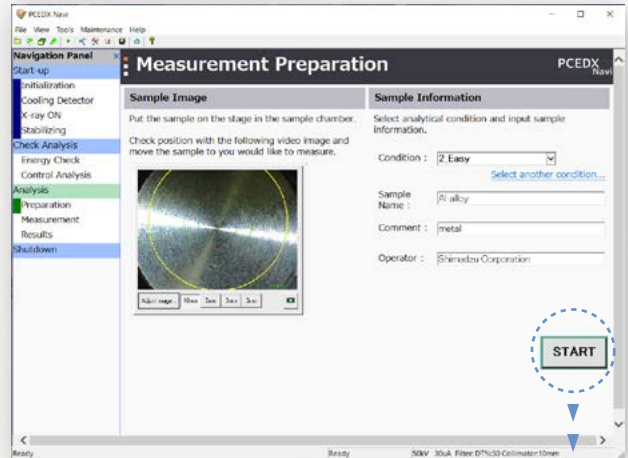

Results Display Screen

Once the measurement is complete, the element names, content, and 3σ (measurement variance) are displayed, together with the sample image, in an easy-to-understand layout. Display the result list and individual report with a single mouse click.

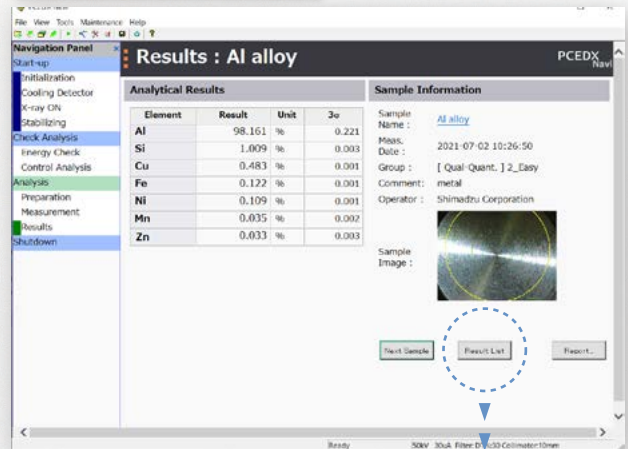

Results List (with images)



Support for Continuous Measurements

PCEDX Navi supports measurements using the optional turret.

Switch between the sample image screen and sample positioning screen.

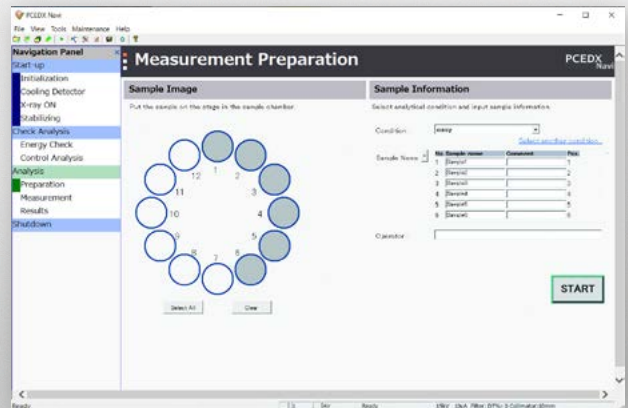

Measurement Setup Screen Using the Turret (sample positioning screen)

Functions to Enhance Usability

Easy Instrument Startup

PCEDX Navi offers instrument initialization and startup (X-ray startup) with simple mouse-click operations.

After instrument startup, the stabilization function operates for 15 minutes. Analysis and instrument checks are disabled during this period, ensuring that all users collect data in a stable instrument environment.

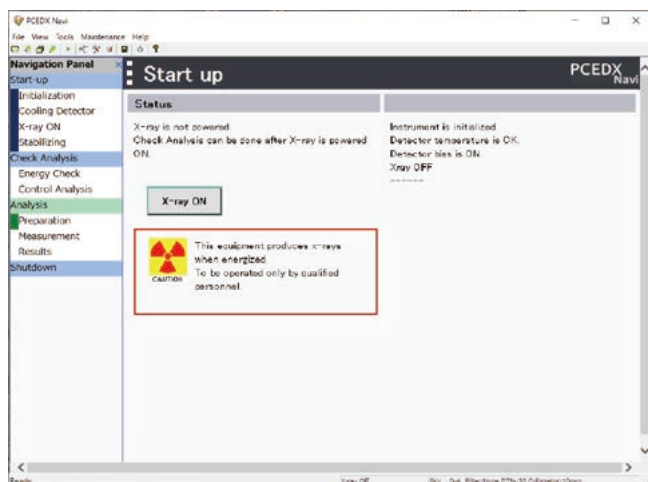

Automatic X-ray Tube Aging

When an X-ray tube has not been used for a long period of time, it requires aging before it can be used again. The software automatically performs the appropriate aging according to the period of non-use.

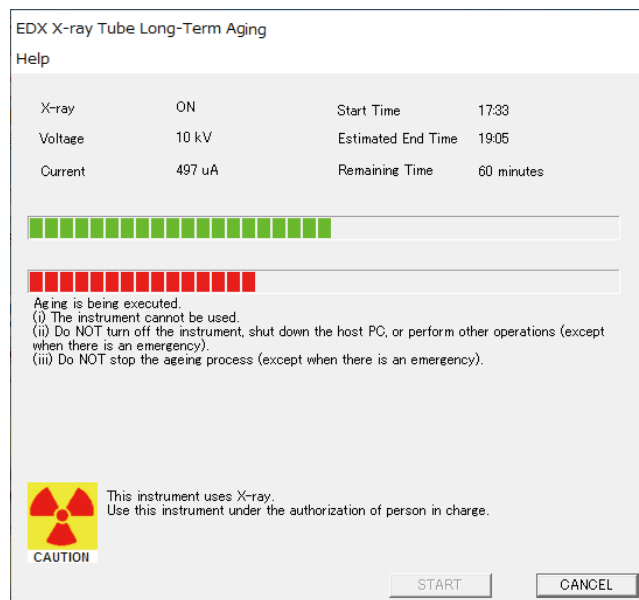

Condition Password Protection

The software offers password protection. Condition settings and changes can only be made by a person who enters the password.

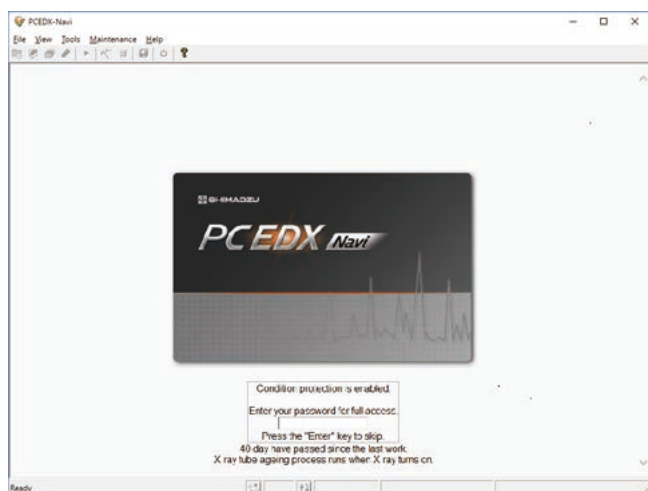

Incorporates General Analysis Software

EDX-7200 incorporates PCEDX Pro software, which offers additional functions. This software offers analysis, conditions settings, and data processing using familiar operations. It also allows loading of data profiles and quantitation values acquired with a previous Shimadzu EDX series instrument.

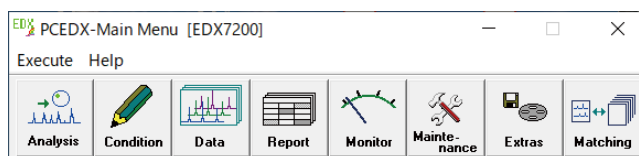

Various Data Output Formats

Report Creation Functions

Analysis data reports can be created in HTML or Excel format. A variety of templates is available.

The sample image automatically saved when measurement starts is pasted in the report for confirmation of the measurement position.

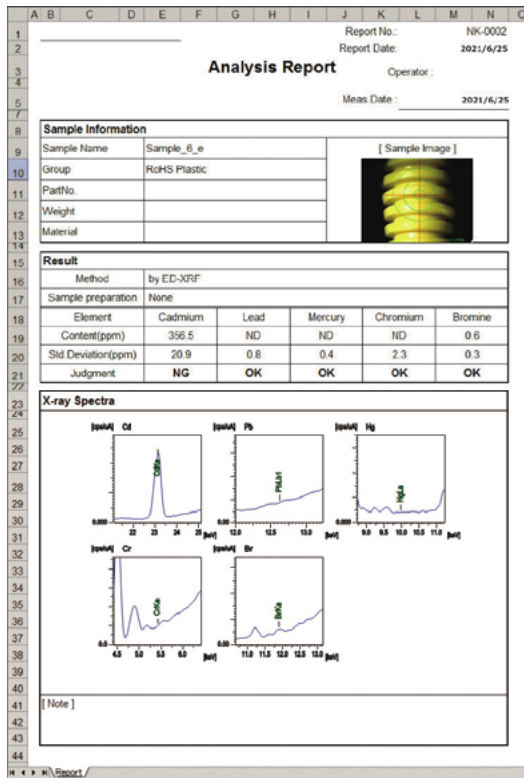

RoHS Screening Report in Excel Format

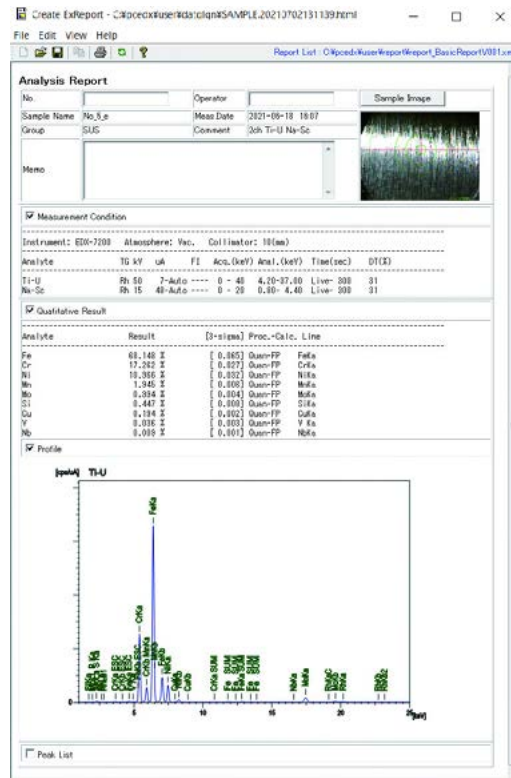

General Analysis Report in HTML Format

*Microsoft® Excel® must be purchased separately.

List Creation Functions

It also allows importing GC-MS text data by specifying a folder.

		Cd		Pb		Hg		Cr		Br		DIBP	DBP	BBP
No.	Sample Name	ppm	3σ	ppm	3σ	ppm	3σ	ppm	3σ	ppm	3σ	mg/kg	mg/kg	mg/kg
4	ERM-EC591											1.477	3.063	0.316
5	Non Cup													
6	PVC													
7	test1	7945.5	325.9	1480.8	5.1	153.3	5.9			140.8	2.6			
8	test2	386.3	19.5	125.9	44.9	15.5	80.1			108.2	23.5			
9	test3	7965.2	331.0	1481.4	5.1	153.4	5.9			140.9	2.6			

User-Definable List of Elements

*Microsoft® Excel® must be purchased separately.

Comprehensive Applications

Powder (Fine particles and coarse particles) –Qualitative and Quantitative Analysis of Rock–

The analysis of powder samples is a typical application of X-ray fluorescence. The sample is either pressure molded or placed in a sample container for analysis. The figure below shows an example of the qualitative and quantitative analysis of rock reference material by Na to U. Accurate quantification is possible even without a standard sample. Light elements can also be measured with high sensitivity by vacuum atmosphere measurement.

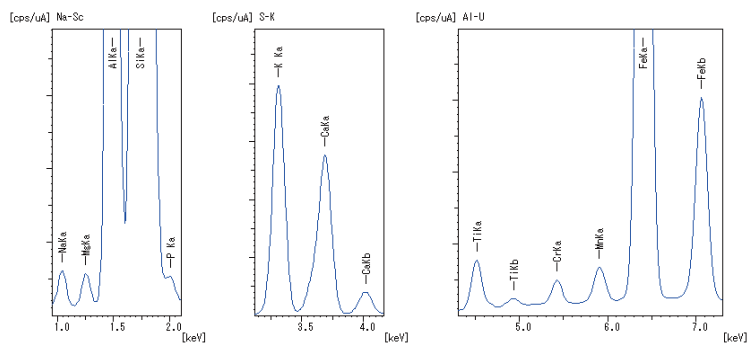

Peak Profile of Rock Reference Material



Sample appearance
(Pressure molding with a total pressure of 250 kN for 30 sec)

Results of quantitative analysis by FP method and comparison of standard values [wt%]

Element	SiO ₂	Al ₂ O ₃	K ₂ O	Na ₂ O	CaO	Fe ₂ O ₃	MgO	TiO ₂	P ₂ O ₅	MnO
Quantitative value	72.03	13.98	4.77	3.57	2.61	1.92	0.56	0.27	0.075	0.066
Standard Value	72.30	14.30	3.96	3.39	2.13	2.00	0.69	0.25	0.083	0.057

Liquid, Slurry and Emulsion –Heavy Elements in Waste Oil–

To measure a liquid sample, simply add it to a sample cell with film on the bottom. This method is effective for the detection and quantitation of additive components and worn metals in aqueous solutions, organic solvents, or oils.

As shown below, the system achieves adequate detection of heavy elements in waste oil at ppm levels.

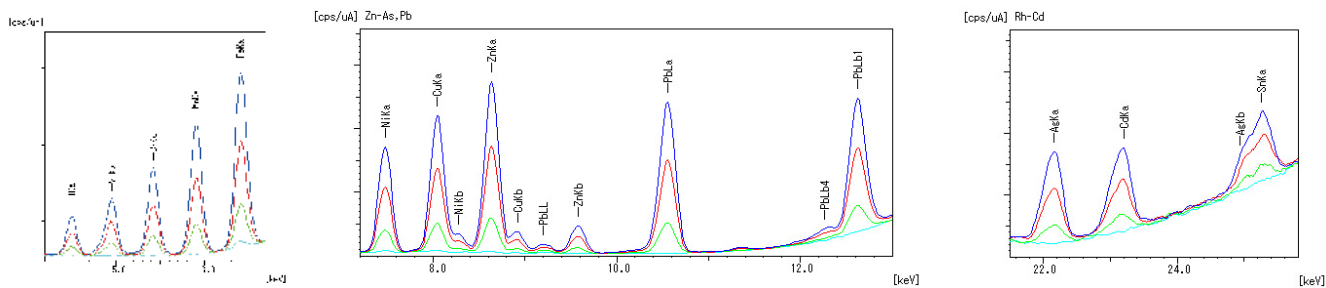

Overlaid Profiles of Heavy Elements in Waste Oil

- Waste oil standard sample (50 ppm each element)
- Waste oil standard sample (30 ppm each element)
- Waste oil standard sample (10 ppm each element)
- Blank sample



Sample Appearance
(Sample cell, film, 5 mL oil)

Foreign Matter Material Evaluation –Foreign Matter Adhering to Plastic Extruded Part–

EDX permits non-destructive elemental testing, making it effective for the analysis of foreign matter adhering to or mixed in with foods, drugs, or products. Using the sample observation camera and collimators makes it easy to identify trace foreign matter.

The 1 mm irradiation diameter is effective at reducing the effects of peripheral material, resulting in accurate quantitative matching. In the example, the material was identified as SUS316.

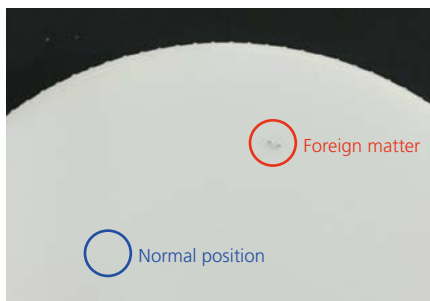

Sample Appearance

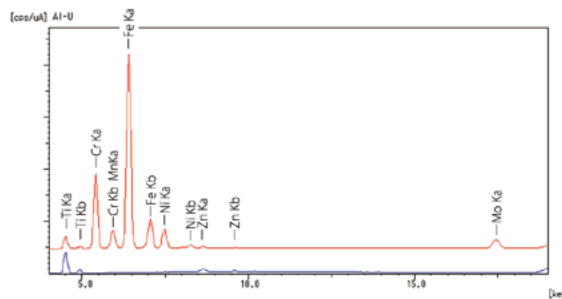

Overlaid Profiles of Foreign Matter (Red) and Normal Position (Blue)

Analyte	Result
Fe	66.443
Cr	17.865
Ni	11.254
Mo	2.433
Mn	2.005

Quantitative Analysis Results for Foreign Matter by FP Method

The titanium (Ti) and zinc (Zn) peripheral material around the foreign matter are eliminated from the quantitation calculations.

Candidate	Diff. Factor
SUS_316	0.67001
SUS_316N	0.67001
SUS_316LN	0.70149
SUS_316L	1.04736
SUS_305	1.29084
SUS_304L	1.23170
SUS_347	1.31167
SUS_321	1.31224
SUS_316J1	1.49829
SUS_317	1.56586

Matching Results
(Matching results in internal library.
Substance identified as SUS316.)

Residual Catalyst –Analysis using Scattered Radiation Correction–

EDX is also useful for testing residual catalysts. For quantitative analysis of residual catalysts during organic synthesis, ICP analysis is often used. However, pretreatment is cumbersome and it takes time to obtain results. EDX makes quantitative analysis easy.

The following is an example of quantitative analysis of Pd in organic matter (cellulose) using a calibration curve prepared with a standard Pd aqueous solution. By using the standard correction in the scattering line, the difference between the material of water and cellulose is corrected. Furthermore, the quantitative result is equivalent to the case of the sufficient quantity even if the sample quantity is small.

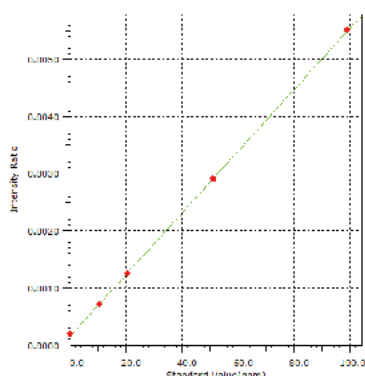

Calibration Curve of Pd Prepared with Standard Aqueous Solution



Sufficient amount (3.0 g) Small amount (0.5 g)
Appearance of cellulose powder sample (using sample container)

Results of Quantitative Analysis of Pd in Cellulose Powder [ppm]

Sample amount	Pd	3σ
Sufficient amount (3.0 g)	21.2	1.0
Small amount (0.5 g)	21.4	1.4

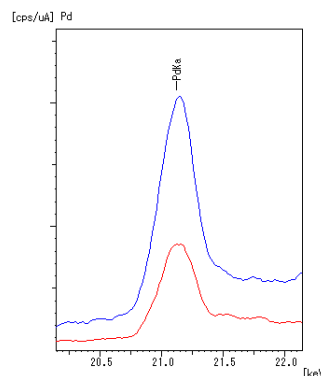

Profile Superposition of Pd on Cellulose Powders with Different Sample Amounts

Comprehensive Applications

New

— Screening Analysis of Phosphorus —

Phenol and isopropyl phosphoric acid (3:1) (PIP (3:1)) are widely used in products such as polyvinyl chloride (PVC) and polyurethane to provide plasticity and flame retardancy. Meanwhile, the U.S. Environmental Protection Agency (U.S. EPA) has begun to regulate the manufacture, processing and commerce of products and articles containing PIP (3:1) under the Toxic Substances Control Act (TSCA).

For this regulation, EDX is capable of screening and analyzing the content of PIP (3:1), a phosphorus compound, at phosphorus concentrations. With the use of an optional vacuum measurement unit, analysis can be performed with even higher sensitivity.

Note: This system detects total phosphorus. This is not a system for just analyzing PIP (3:1).

When phosphorus is detected, GC/MS is useful for investigating whether it was derived from PIP (3:1).

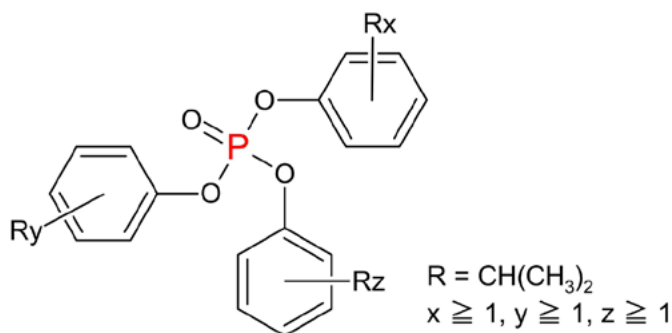

PIP (3:1) Structural Formula

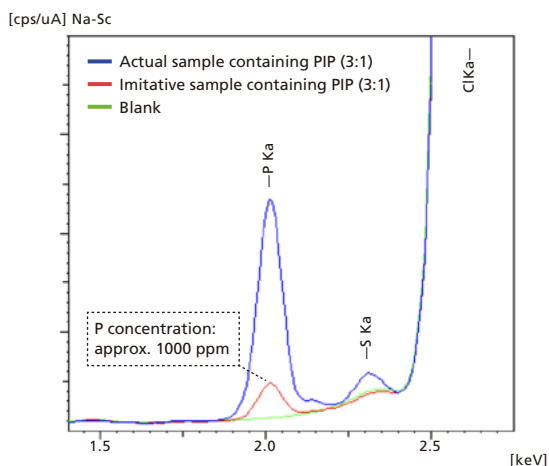

Profile Superposition of Sample Containing PIP (3:1) and Blank

*The imitative sample containing PIP (3:1) is prepared by adding PIP (3:1) to petroleum ether so that the concentration of phosphorus (P) is 1000 ppm. In addition, PVC is assumed as the material and chlorinated paraffin is added to mix chlorine (Cl).

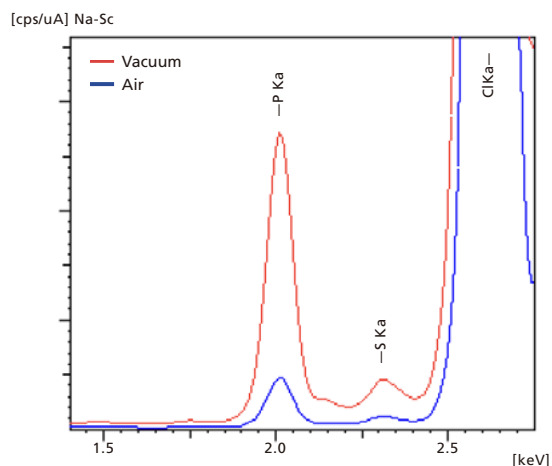

Profile Superposition of Vacuum and Atmosphere Measurements of Actual samples Containing PIP

New

—Example of Analysis using Screening Analysis Kit—

Shown here are results from an analysis of PVC resin containing P using the optional Phosphorus (P) Screening Analysis Kit.

*For details of screening kits, see pages 22 to 24.

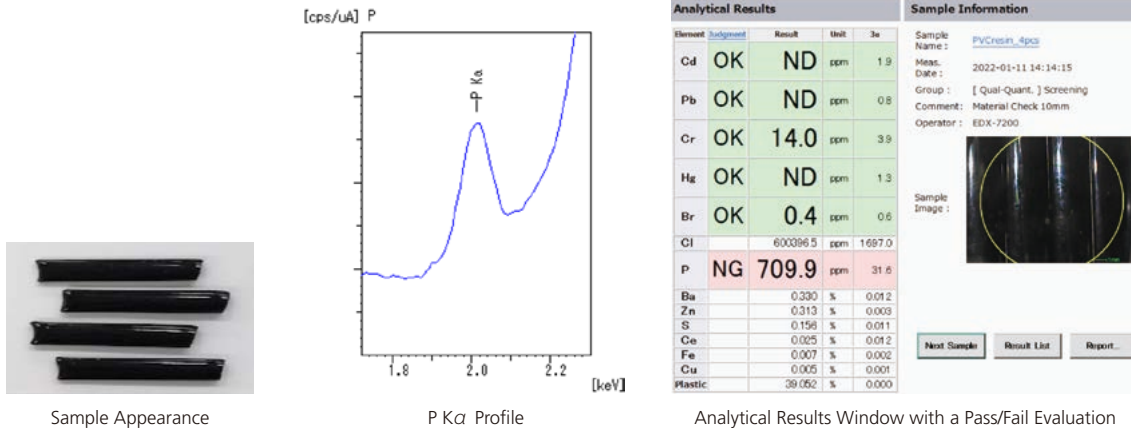

New

—Quantitative Analysis of Titanium Oxide in Antibacterial Coating Agent—

Primary filters are useful for trace element analysis. The EDX series is equipped with five primary filters, one of which is newly incorporated into the EDX-7200 and is particularly useful for analysis from Ti to Co.

The figure below shows results from a quantitative analysis using the FP method of the amount of coating agent adhering to a titanium oxide photocatalyst coating applied to a resin before and after wiping it with a chlorine-based disinfectant cleaner and alcohol. The primary filter enables highly sensitive analysis of trace amounts of Ti before and after wiping.

Summary of Samples

Sample Name	Pretreatments
Sample①	Apply titanium oxide photocatalyst coating agent to polypropylene (PP) sheet
Sample②	Wipe the sample① with a chlorine-based disinfectant cleaner.
Sample③	Wipe the sample① with ethanol.
Uncoated sample	Polypropylene (PP) sheets only

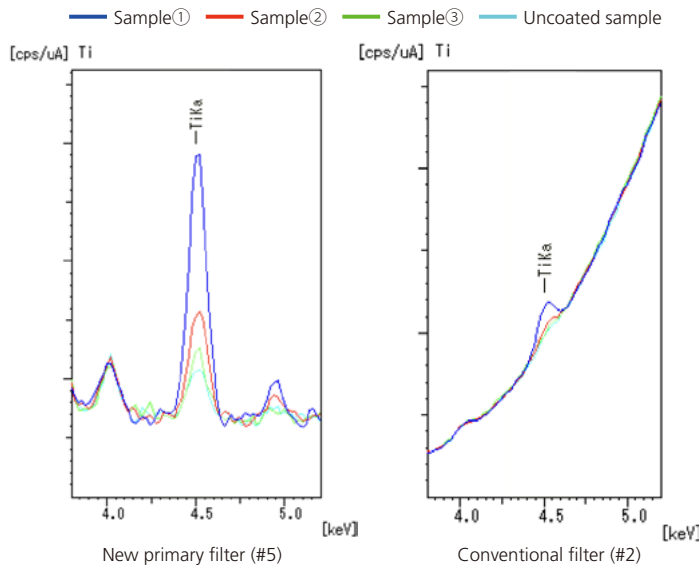

Sample Appearance

Results of Quantitative Analysis [$\mu\text{g}/\text{cm}^2$]

Sample Name	TiO $_2$ Adhesion Amount
Sample①	0.121
Sample②	0.033
Sample③	0.005

Sample Preparation

Solid Samples

- Large samples (> 13 mm dia.)
- Small samples (< 13 mm dia.)



Simply mount in the instrument.



Cover the bottom of the cell with film and add the sample.



Cover with film.

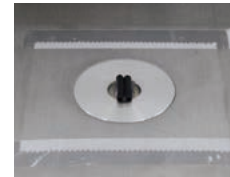

Cover the measuring window with film and place the sample on it.

Pretreatment of metal samples

To enhance the quantitation precision for metal samples or to eliminate the effects of contamination or oxidation on the sample surface, machine and polish the sample surface with a lathe and rotary polishing machine.



Machined and polished sample

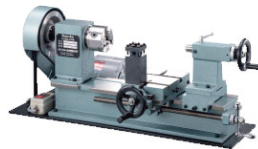

Lathe

Liquid Samples

- Measurement in atmosphere or with helium purging
- Measurement in a vacuum



Cover the bottom of the cell with film and add the sample.

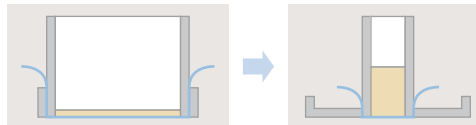

If a small volume of sample results in inadequate thickness (depth), use a Micro X-Cell. (This also applies to powder samples.)



Perform measurements on sample dripped onto special filter paper and dried.

Powder Samples



Cover the bottom of the cell with film and add the sample (loose powder method).



Press form the powder with a press machine (briquette press method).



Press machine



Flat press heads

Pulverizing Samples

Pulverize samples with coarse particle sizes, or samples subject to effects of non-uniformity of mineral particles on the analysis surface.



Pulverizing container
Automatic Pulverizer

Glass Bead Method

The glass bead method provides highly accurate analysis of oxide powders, such as rock. The sample is glassified using a flux such as $\text{Li}_2\text{B}_4\text{O}_7$.



Screening Analysis Kits (Option)

Ideal for RoHS, ELV, and Halogen Screening

The optional screening analysis kits allow even beginners to start RoHS, halogen, or antimony screening analysis right from the day of purchase. Simply mount the sample, select the analysis conditions, enter the sample name, and wait for the results. The analysis results are displayed with a pass/fail evaluation after just a few minutes. RoHS extended elements (P, Cl, Sn, Sb) are also supported by the optional RoHS enhanced screening kits, and ease of use has been improved with a more accurate threshold evaluation.

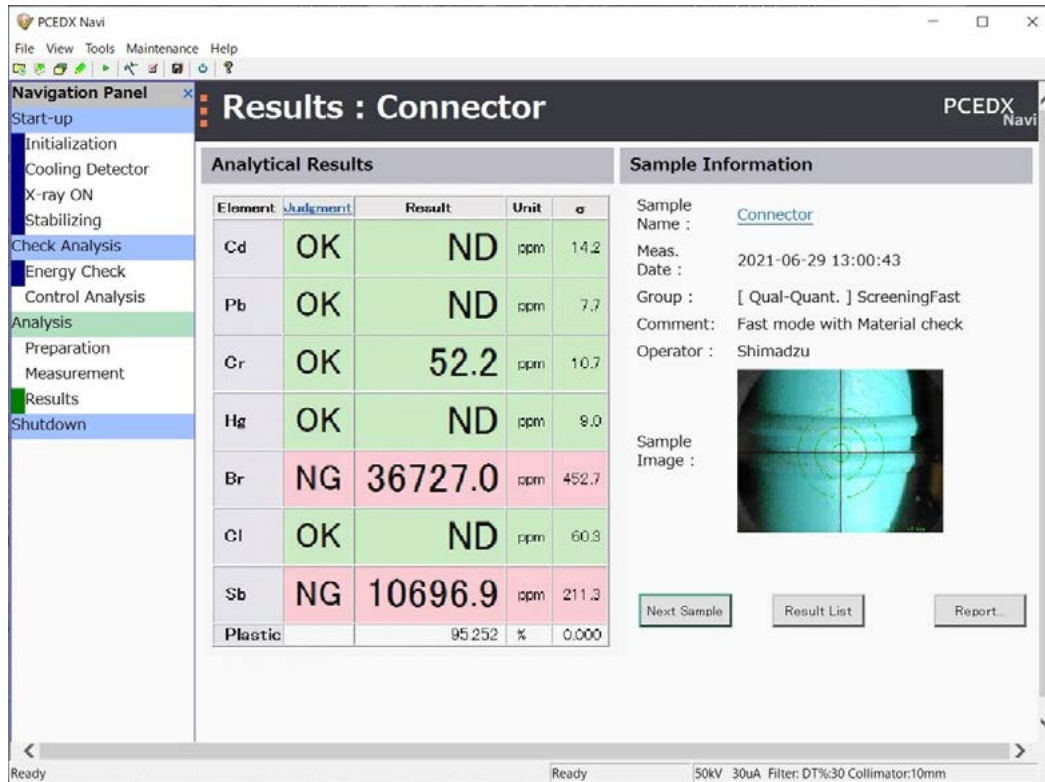

Analytical results window using the RoHS, Halogen and Antimony screening kit

Internal Calibration Curves and Automatic Calibration Curve Selection

Internal calibration curves

Internal calibration curves are provided for many materials, making it unnecessary to provide a large number of standard samples.

Automatic calibration curve selection

The software automatically selects the best calibration curve for the material, freeing the user from the need to select analysis conditions.

As an incorrect calibration curve selection can result in a large error in the quantitation results, this function contributes to more reliable data.

Shape correction

The fluorescent X-ray and scattered X-ray intensities are compared for each element (BG internal standard method) to eliminate the effects of the sample shape and thickness in the quantitation values.

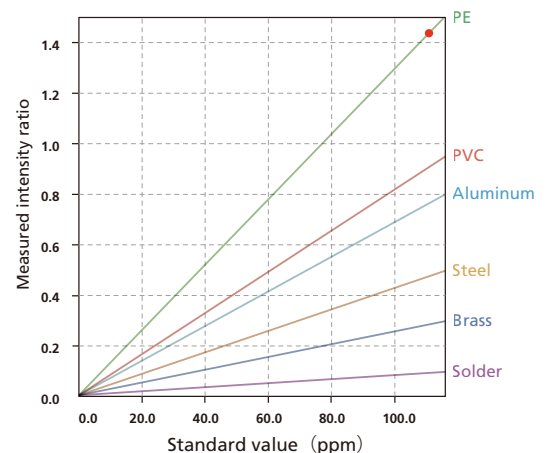

Screening Analysis Kits (Option)

New

Automatic Measurement Time Reduction



This function automatically switches to the next analysis channel if a controlled substance clearly has a high or low concentration, making evaluation possible while measurement is underway. This achieves more efficient screening analysis.

- Clearly above the control standard, so measurement is cut off.
- Clearly in the gray zone, so measurement is cut off.
- Clearly below the control standard, so measurement is cut off.

By improving the count rate, the screening accuracy has been improved with the same measurement time as conventional equipment. In addition, the software reduces the time that was unconditionally measured until the time set in the gray zone.

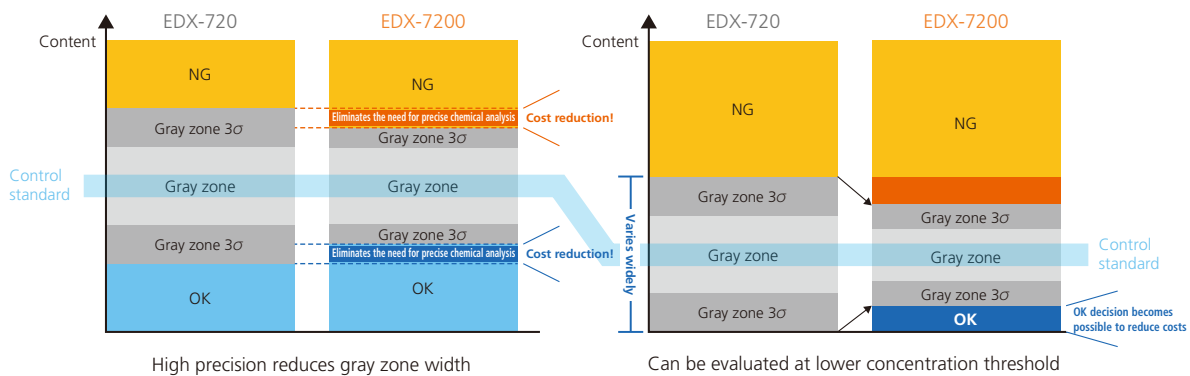
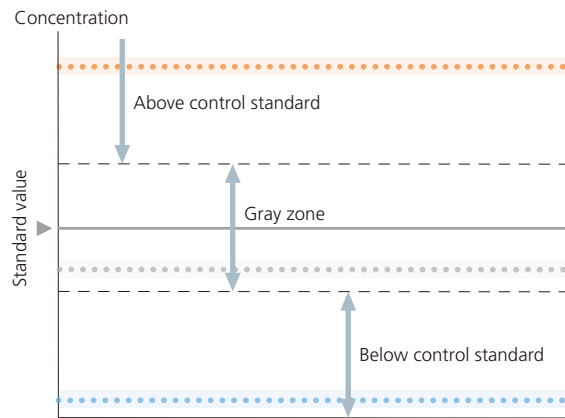

Time-saving function diagram

Screening Simple Setup Screen

Threshold Values

A threshold value can be set for each material and element. The screening evaluation method changes according to how the threshold values are set.

Evaluation Character String

Character strings can be set for display in the analysis results when the threshold value is not exceeded, in the gray zone, and when the threshold value is exceeded.

Report Template

Set the report style from among the templates supplied as standard.

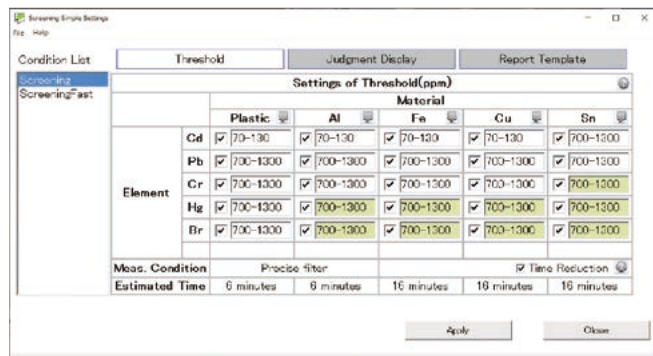

Simple Setup Screen of RoHS Screening Analysis Kit

Three screening analysis kits are available to suit different applications.

RoHS Screening Analysis Kit

Kit for screening cadmium, lead, mercury, chromium, and bromine. Polyethylene samples containing these five elements are supplied in the kit for instrument management.



New

Phosphorus (P) Screening Analysis Kit*^{1,2}

Kit for screening of phosphorus in flame retardants in resins. Can also be used for trace evaluation. Samples containing phosphorus are supplied in the kit for instrument management.



New

RoHS and Halogen Screening Analysis Kit

In addition to cadmium, lead, mercury, chromium, and bromine, this kit supports the screening of chlorine in plastics. Polyethylene samples containing these six elements are supplied in the kit for instrument management.



Tin (Sn) Screening Analysis Kit*²

Kit for screening of Tin (Sn) in resins. Can also be used for trace evaluation. Samples containing tin are supplied in the kit for instrument management.



RoHS, Halogen, and Antimony Screening Analysis Kit

In addition to cadmium, lead, mercury, chromium, and bromine, this kit supports the screening of chlorine and antimony in plastics. Polyethylene samples containing these seven elements are supplied in the kit for instrument management.



*1 See page 18 of this brochure for an example of phosphorus (P) screening analysis.

*2 The P and Sn screening kits cannot be used alone. Be sure to use them with one of the RoHS screening analysis kits (described on the left)



EDXIR-Analysis™ Software (Option)

EDXIR-Analysis software is specially designed to perform qualitative analysis using data acquired by an energy dispersive X-ray (EDX) fluorescence spectrometer and a Fourier transform infrared (FTIR) spectrophotometer.

This software is used to perform an integrated analysis of data from FTIR, which is excellent at the identification and qualification of organic compounds, and from EDX, which is excellent at the elementary analysis of metals, inorganic compounds and other content. It then pursues identification results and the degree of matching. It can also be used to perform EDX or FTIR data analysis on its own.

The library used for data analysis (containing 485 data as standard) is original to Shimadzu, and was created through cooperation with water supply agencies and food manufacturers. Additional data can be registered to the library, as can image files and document files in PDF format. It is also effective for the linked storage of various types of data as electronic files.

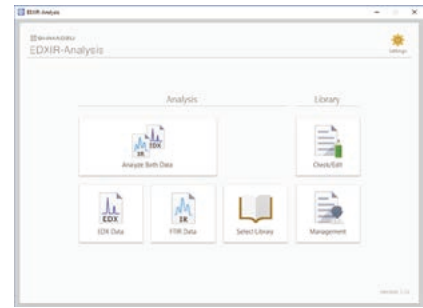

Integrated Analysis of Contaminant Data and Data Comparisons for Confirmation Tests

To perform qualitative analysis automatically, simply click "Analyze Both Data" and select the EDX/FTIR data*1. This heightens the efficiency of data analysis and provides strong support for contaminant analysis.

In addition to a list of hits, the integrated data analysis results show EDX profiles and FTIR spectra found as hits from the library. If the user wishes to browse the respective data analysis results, they can be checked by clicking "Single".

In addition, with the data comparison function, which calculates the degree of matching between the actual measured data and the data registered in the library, the software can be used for countermeasures against "silent change"*2 and for other confirmation tests. Clicking the "Print" button prints the results in a fixed format and also saves them in Word format*3.

*1: Using the EDX profile, data are classified as inorganic, organic, and mixture. Integrated data analysis is performed by applying priority levels to each classification. (Patent pending)

*2: A term used in Japan to indicate changes to materials by suppliers without the knowledge of the manufacturers.

*3: Microsoft® Word must first be installed.

The examples here show an integrated analysis of black rubber contaminant data acquired and a data comparison for a polyvinyl chloride (PVC) examination object and the standard product. From the integrated data analysis results, it is evident that the black rubber contaminant is acrylonitrile-butadiene rubber (NBR), which contains calcium carbonate and zinc stearate. In addition, from the data comparison, the degree of matching between the PVC examination object and the standard product is 0.8506. Lead (Pb) and acrylic were detected from the EDX and FTIR data, but were not detected in the standard product. Accordingly, it is surmised that the examination object contains components different to those in the standard product.



Integrated Data Analysis Results for a Black Rubber Contaminant

Data Comparison Results for a PVC Examination Object and the Standard Product

Data Browsing and the Registration, Editing, Deletion of Data, Images, Document Files

By clicking "Edit" and selecting an existing library, the data, images and documents registered in the selected library can be browsed. Data can be registered, edited, deleted. A new library can also be created.

In addition, if data for a sample were acquired by instruments other than EDX and FTIR instruments (such as a chromatograph, mass spectrometer, or surface observation system), it can be converted into PDF format and then registered, enabling linked storage to the EDX/FTIR data.

Edit

ID	Sample Name	Comment	EDX Data	FTIR Data	Detail
0001	Contaminant 001 String seal	String seal Materials/Polymers/Plastics/...	✓	✓	Detail
0002	Contaminant 002 String seal D	String seal Materials/Polymers/Plastics/...	✓	✓	Detail
0003	Contaminant 003 Inertion packing Outside	Inertion packing Outside Materials/...	✓	✓	Detail
0004	Contaminant 004 Inertion packing Inside	Inertion packing Inside Materials/...	✓	✓	Detail
0005	Contaminant 005 Pipe 1/2 inch packing Outside	Pipe 1/2 inch packing Outside Materials/...	✓	✓	Detail
0006	Contaminant 006 Pipe 1/2 inch packing Inside	Pipe 1/2 inch packing Inside Materials/...	✓	✓	Detail

EDX Profiles, Quantitation Results, EDX Photographs, Comments, and Other Information

FTIR Spectra and Comments

Browsing Document Files

Photographs, Document Files, Comments, and Other Information

Browsing Registered Photographs

All Data Is Linked and Stored

Sample Holder/Stocker for Contaminant Measurement EDXIR-Holder™ (Option)

Measure the Samples Kept in the Holder with EDX and FTIR
The Holder Can Be Used as the Sample Stocker after the Measurement

Enables More Efficient Analyses

This foldable holder consists of an adhesive layer with samples attached and polypropylene film designed for a fluorescence X-ray. When using EDX for measurement, close the holder and place the polypropylene film directly to the irradiation side (downside). When using FTIR for measurement, open the holder and press the samples attached to the adhesive layer against the ATR prism. This enables the replacement of samples, at a minimum, saving on labor and making analysis more efficient.

Prevents Loss of Samples

Close the holder after the measurement and it can be used as a sample stocker. It is not necessary to transfer the samples to other containers, so there is no danger of losing samples.

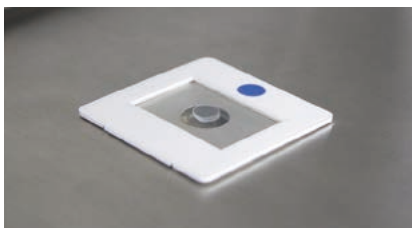

How to Use with EDX

Close the holder and place the polypropylene film to the irradiation side (downside).

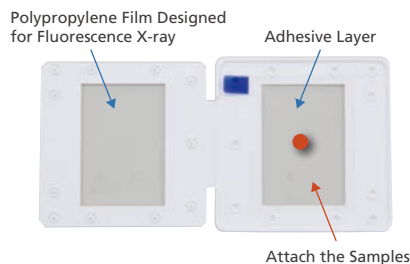

When the Holder is Open (Inside of the Holder)

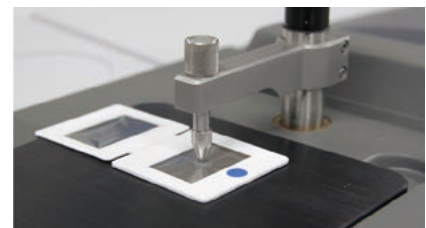

How to Use with FTIR

Open the holder and press the samples attached to the adhesive layer against the prism.

Small Spot Analysis Kit (Option)

For Analysis of Small Contaminants and Defect Analysis in Small Regions

This option can be used to analyze even smaller areas by replacing the collimator plate and sample observation camera. It is especially useful for analyzing trace foreign matter and defects in micro areas, and measuring plating thickness.

Minimum 0.3 mm X-Ray Irradiation Diameter

The excitation X-rays can be collimated to 0.3 mm in diameter, which is effective for the high-accuracy analysis of small contaminants and for defect analysis in small regions, analyses difficult with standard specifications (minimum 1 mm in diameter).

Enlarged Sample Images without Image Quality Degradation

This system supports smaller samples, which heightens the visibility of sample observation images. Users can switch to an enlarged image approximately 2.5 times larger than a previous image, without image quality degradation.

Automatic Four-Stage Switching Between 0.3, 1, 3, and 10 mm in Diameter

The irradiation diameter automatically switches between 0.3, 1, 3, and 10 mm in diameter. This system supports not only the analysis of small spots but also macro composition analysis at 10 mm in diameter.

Note: The irradiation diameter is the size on the sample surface.

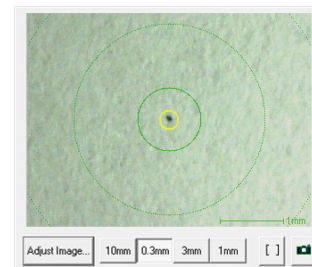
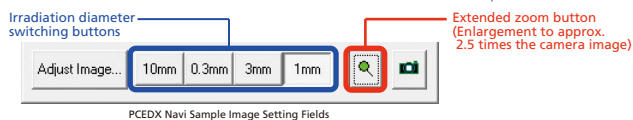

Sample Image at an Irradiation Diameter of 0.3 mm (Extended Zoom)
Sample: stainless powder (approx. 0.1 mm) collected on filter paper

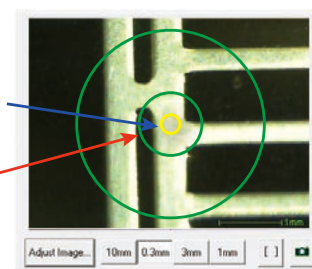

Metal Plated Terminals
(At 1 mm in diameter, the irradiation area is not within the measurement area, so measurements are impossible. At 0.3 mm in diameter, measurements are possible.)

Analysis Example—Small Metal Powder (Approx. 0.1 mm in Diameter) Adhered to the Surface of Snacks

A small metal powder approximately 0.1 mm in diameter adhered to the commercially available snacks was analyzed with irradiation diameters of 1 mm and 0.3 mm, respectively. At an irradiation diameter of 1 mm, the overall background is significantly increased due to the influence of scattered X-rays from the surrounding area of the metal powder (snacks), resulting in a poor S/N ratio. At an irradiation diameter of 0.3 mm, however, the influence of scattered X-rays from the surrounding area is small, and peak profiles with a good S/N ratio are obtained.

Copper (Cu) and Zinc (Zn) are detected as the major components with both irradiation diameters. It indicates that the metal powder is brass regardless of the irradiation diameter used. However, at 0.3 mm in diameter, the peak of Lead (Pb) is also identified, which suggests that the metal powder is “free cutting brass”.

By using an irradiation diameter of 0.3 mm, more accurate analyses can be performed, even for small contaminants on substances such as organic materials that strongly scatter X-rays.

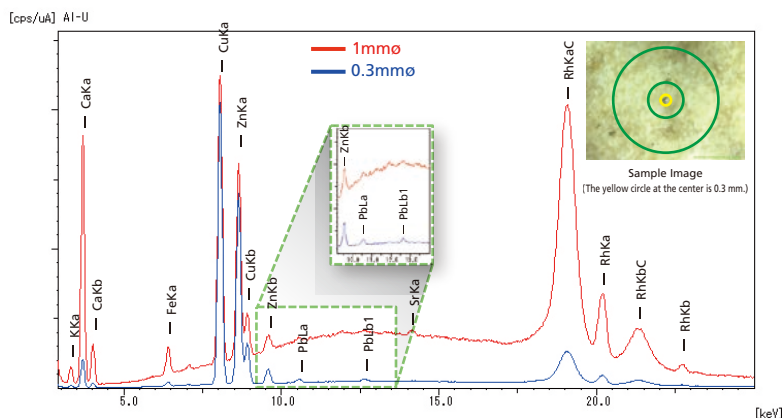

Specifications

Measurement principle	X-ray fluorescence spectrometry
Measurement method	Energy dispersion
Target samples	Solids, liquids, powders
Measuring range	¹¹ Na to ⁹² U (EDX-7200)
Sample size	W 300 × D 275 × approx.H 100 mm (excluding radiuses)
Maximum sample mass	5kg (200g per sample when using turret, Gross mass 2.4kg)

X-ray generator

X-ray tube	Rh target (Standard model/Premium model)* ¹
Voltage	4 kV to 50 kV
Current	1 μA to 1000 μA
Cooling method	Air-cooled (with fan)
Irradiated area	Automatic switching in four stages: 1, 3, 5, and 10 mm diameter Automatic switching in four stages: 0.3, 1, 3, and 10 mm diameter* ¹
Primary filters	Five types (six, including the open position), automatic replacement

Detector

Type	Silicon drift detector (SDD)
Liquid nitrogen	Not required (electronic cooling)

Sample chamber

Measurement atmosphere	Air, vacuum* ² , helium (He)* ²
Sample replacement	12-sample turret* ²
Sample observations	Semiconductor camera

Data processor

CPU	Intel® Core™ i5 or above
Memory	4 GB min.
HDD	250 GB min.
Optical drive	Super multi drive
OS	Windows® 10 pro (64-bit)* ³

Software

Qualitative analysis	Measurement/analysis software
Quantitative analysis	Calibration curve method, correction for coexistent elements, FP method, film FP method, background FP method
Matching software	Intensity/content
Utilities	Automatic calibration functions (energy calibration, FWHM calibration)
Others	Instrument status monitoring function, analysis results tabulation function

Installation

Temperature	10 °C to 30 °C (temperature fluctuation rate 2 °C/hour max., temperature fluctuation range: 10 °C max.) 12 to 30 °C when using vacuum measurement unit (option)
Relative humidity	40 % to 70 % (no condensation)
Power supply	100-240 V AC ±10 %, 2 A earthed socket
Dimensions	W 460 × D 590 × H 360 mm
Weight	Approx. 45 kg

*¹ Premium models with more durable X-ray tube windows.

*² Option

*³ Microsoft® Office is not included.

Installation Example

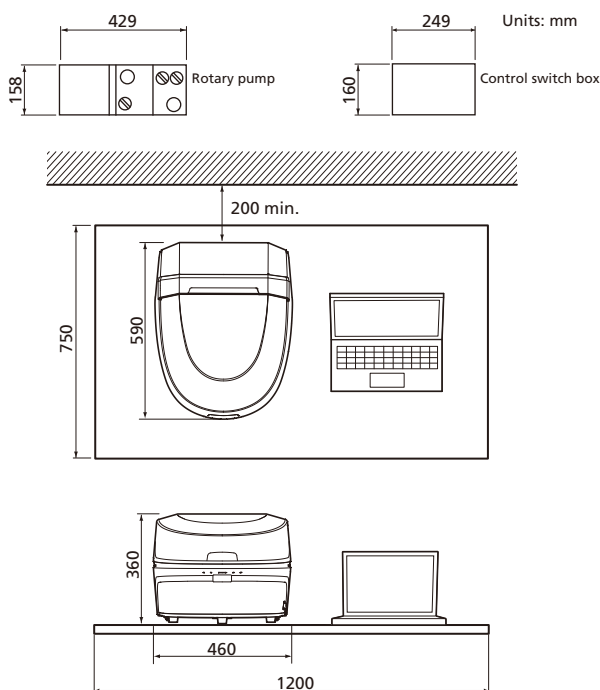

Vacuum measurement unit (optional) consists of a control switch box and rotary pump.



This product conforms to Shimadzu's Eco-labeled designation.

* Energy savings: 44.1% reduction as compared to the previous model

EDX-7200

Energy Dispersive X-Ray Fluorescence Spectrometer

Options

Vacuum Measurement Unit P/N 212-25425-42

Use this unit for sensitive measurements of light elements. It requires space for installation of a rotary pump and switch box at the side or rear of the desk supporting the main unit.

Helium Replacement Measurement Unit

P/N 212-25440-42

This unit is used for highly sensitive measurements of light elements in liquid samples. Does not include a helium cylinder or regulator.

Turret Unit P/N 212-25389-41

Turret for 12 samples. It permits continuous measurements of samples up to 32 mm in diameter. It improves throughput, especially for measurements in a vacuum or helium atmosphere.



Small Spot Analysis Kit

P/N 212-25880-41

This kit is especially useful for analyzing trace foreign matter and micro areas.

This combination includes a 0.3 mm diameter collimator and high-resolution camera.

Screening Analysis Kits

P/N 212-11110-41

RoHS/ELV Screening Analysis Kit

With check samples for five elements

P/N 212-11111-41

RoHS and Halogen Screening Analysis Kit

With check samples for six elements

P/N 212-11112-41

RoHS, Halogen, and Antimony Screening Analysis Kit

With check samples for seven elements

New

P/N 212-11062-41

Phosphorus (P) Screening Analysis Kit

New

P/N 212-11061-41

Tin (Sn) Screening Analysis Kit

EDX-FTIR Contaminant Finder/Material Inspector EDXIR-Analysis software

P/N 206-33175-92/93

By measuring the sample with both EDX and FTIR systems and using EDXIR-Analysis to analyze both EDX and FTIR data, elements can be identified automatically with high accuracy.

Sample Cells

3571 General Open-End X-Cell (no lid)

P/N 219-85000-55 (100 cells/set)

(Outer diameter: 31.6 mm, volume: 10 mL)

Polyethylene sample cell for liquid and powder samples.



3529 General X-Cell (with lid)

P/N 219-85000-52 (100 cells/set)

(Outer diameter: 32 mm, volume: 8 mL)

For liquid samples. Equipped with a relief hole and liquid retainer in case of liquid expansion.



3577 Micro X-Cell

P/N 219-85000-54 (100 cells/set)

(Outer diameter: 31.6 mm, volume: 0.5 mL)

For trace samples. Recommended for use with a collimator.



3561 Universal X-Cell

P/N 219-85000-53 (100 cells/set)

(Outer diameter: 31.6 mm, volume: 8 mL)

For liquid and thin-film samples. Equipped with a relief hole and liquid retainer in case of liquid expansion. Equipped with a ring to tightly hold thin-film samples with film.



X-ray Tube (Premium type)

P/N 212-24541-41

Premium models with more durable X-ray tube windows. The warranty period is 2 years. (Standard type is 1 year).

Polyester Film

P/N 202-86501-56 (500 sheets/set)
Sample-holding film (for heavy element analysis)

Polypropylene Film

P/N 219-82019-05 (73 mm W x 92 m roll)
Sample-holding film (for light element analysis)

Spotting Filter Paper

P/N 210-16043-50 ϕ 30 mm 50 sheets/set
P/N 210-16043-51 ϕ 20 mm 50 sheets/set
Drop a liquid sample on the filter paper, dry, and analyze.



Filter Paper Holder

P/N 205-07221



Briquet Press MP-35

Operation	Automatic
Press	Hydraulic
Maximum Pressure	350 kN
Pressure Setting	Arbitrary with a valve
Method	Place the sample in a cup or the ring and press it.
Press head	Plane type
Power	3-phase, 200 V \pm 10 %, 50/60 Hz, 3 A
Dimension	W 500 x D 500 x H 1210 mm
Weight	240 kg



Flat press heads

Sample Holder/Stocker for Contaminant Measurement EDXIR-Holder

P/N 212-25890-41 (25 sheets)

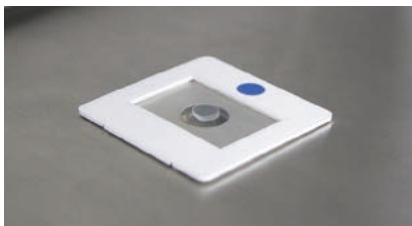

How to Use with EDX

Close the holder and place the polypropylene film to the irradiation side (downside).

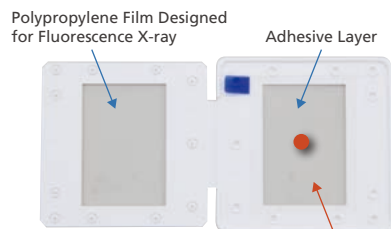

Attach the Samples

When the Holder is Open
(Inside of the Holder)

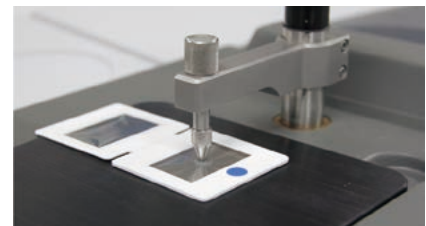

How to Use with FTIR

Open the holder and press the samples attached to the adhesive layer against the prism.

Briquetting Ring

The vinyl chloride resin rings are used for silicate samples, while the aluminum rings are used for other types of samples, such as cement.

Materials	Aluminum Rings				
	P/N 202-82397-53	ID ϕ 35 mm	OD ϕ 35 mm	Analysis dia. ϕ 30 mm	500pcs/set
	Vinyl chloride				
	Recommendation				
	P/N 212-21654-05	ID ϕ 22 mm	OD ϕ 26 mm	Analysis dia. ϕ 20 mm	100pcs/set
	Others				
	P/N 212-21654-01	ID ϕ 35 mm	OD ϕ 42 mm	Analysis dia. ϕ 30 mm	100pcs/set
	P/N 212-21654-02	ID ϕ 35 mm	OD ϕ 42 mm	Analysis dia. ϕ 30 mm	500pcs/set
	P/N 212-21654-11	ID ϕ 25 mm	OD ϕ 32 mm	Analysis dia. ϕ 20 mm	100pcs/set
	P/N 212-21654-12	ID ϕ 25 mm	OD ϕ 32 mm	Analysis dia. ϕ 20 mm	500pcs/set
	P/N 212-21654-09	ID ϕ 14 mm	OD ϕ 18 mm	Analysis dia. ϕ 10 mm	100pcs/set
	P/N 212-21654-10	ID ϕ 14 mm	OD ϕ 18 mm	Analysis dia. ϕ 10 mm	500pcs/set

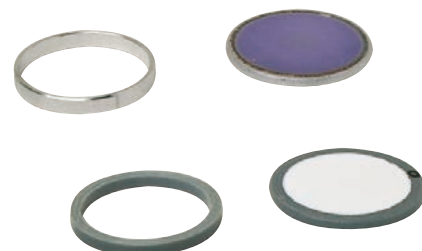

Options

New

Sample Holder Ring Removal Kit

This kit is for removing the ring that holds the film attached to the sample container.

The ring can be removed by inserting the assembled sample container into the kit body and pushing the push bar from the top.



New

Fall Prevention Fitting

Metal fitting for preventing equipment falling from the installation table.

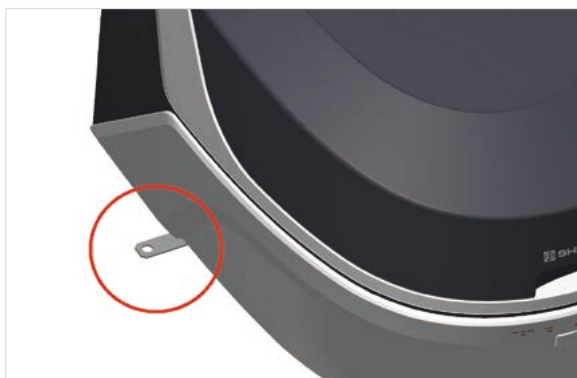

Note: When preparing for slippage or falling due to an earthquake, etc., install presser brackets on the equipment legs and take anti-earthquake measures on the installation table itself.



ANALYTICAL INTELLIGENCE

- Automated support functions utilizing digital technologies, such as M2M, IoT, and Artificial Intelligence (AI), that enable higher productivity and maximum reliability.
- Allows a system to monitor and diagnose itself, handle any issues during data acquisition without user input, and automatically behave as if it were operated by an expert.
- Supports the acquisition of high quality, reproducible data regardless of an operator's skill level for both routine and demanding applications.

EDXIR-Analysis, EDXIR-Holder and eco logo are trademarks of Shimadzu Corporation or its affiliated companies in Japan and/or other countries. Microsoft, Excel and Windows are either registered trademarks or trademarks of Microsoft Corporation in the United States and/or other countries. Intel and intel core are trademarks of Intel Corporation or its subsidiaries. X-Cell is a trademark of SPEX SamplePrep, LLC.



Caution

This unit is designated as an X-ray device.



Shimadzu Corporation

www.shimadzu.com/an/

For Research Use Only. Not for use in diagnostic procedures.

This publication may contain references to products that are not available in your country. Please contact us to check the availability of these products in your country.

Company names, products/service names and logos used in this publication are trademarks and trade names of Shimadzu Corporation, its subsidiaries or its affiliates, whether or not they are used with trademark symbol "TM" or "®".

Third-party trademarks and trade names may be used in this publication to refer to either the entities or their products/services, whether or not they are used with trademark symbol "TM" or "®".

Shimadzu disclaims any proprietary interest in trademarks and trade names other than its own.

The contents of this publication are provided to you "as is" without warranty of any kind, and are subject to change without notice. Shimadzu does not assume any responsibility or liability for any damage, whether direct or indirect, relating to the use of this publication.