

Imaging Mass Microscope

# iMScope QT





**The One and Only**

# Next-Generation Mass Spectrometry Imaging Created by iMScope™ QT

Inheriting the concept of a mass spectrometer equipped with an optical microscope from the iMScope series, the iMScope QT is also Shimadzu's flagship model for MS imaging with a Q-TOF MS.

The iMScope QT boasts not only fusion with morphology studies but also excellent speed, sensitivity, and spatial resolution, clearing the way to next-generation mass spectrometry imaging.

- **Combined Analysis**

Fusion of MS images with optical microscope observations.

- **Quantification and Distribution**

Obtain qualitative and quantitative information from LC-MS as well as position information from mass spectrometry imaging with a single instrument.

- **High Resolution, Speed and Accuracy**

Acquisition of accurate, high-speed, high-resolution MS images together with efficient data analysis.

## iMScope QT

IMAGING MASS MICROSCOPE



# Total System for MS Imaging Analysis

Mass spectrometry imaging is performed in three steps: pretreatment, data acquisition, and data analysis. At each step, the optimal approach accelerates research, while improving the reliability of the results.

## Key Points for MS Imaging

### Pretreatment

Repeatability  
Automation  
Crystal Refinement

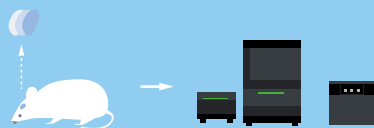

### Data Acquisition

High Spatial Resolution  
High Speed  
Quantification

#### Matrix Spray



Matrix Vapor Deposition System  
iMLayer™

Pretreatment, which normally requires know-how to increase ionization efficiency, has been automated.



Automatic Sprayer for MALDI Imaging  
iMLayer™ AERO

Creation of  
consecutive  
sections



Imaging Mass Microscope  
iMScope™ QT

Users can **easily switch** between imaging analysis and LC-MS analysis.



Quadrupole Time-of-Flight Liquid  
Chromatograph Mass Spectrometer  
LCMS-9030

## Data Analysis

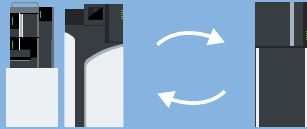

Convenience  
Diversity  
Universality

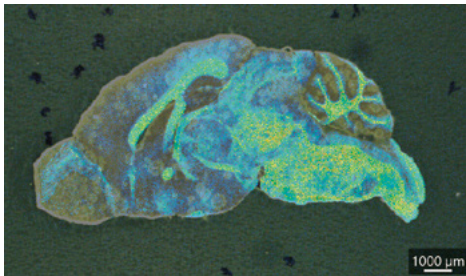

Overlaying optical microscope images with MS images

The mass spectrometer is equipped with an optical microscope, so data analysis can **match the optical microscope images** to the MS images.

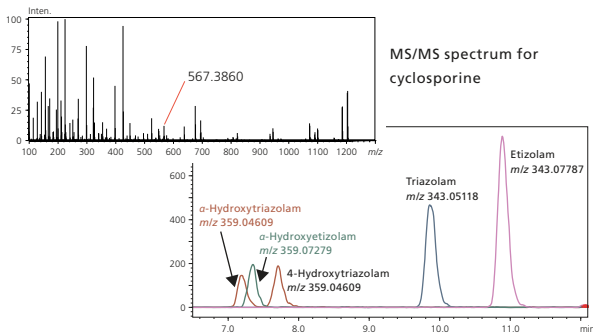
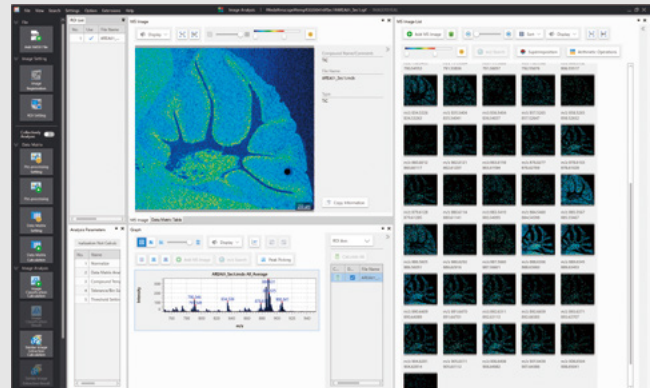

Mass chromatogram of etizolam, triazolam, and their metabolites, added to whole blood at a concentration of 10 ng/ml

### Quantitative Analysis



Data analysis with  
IMAGEREVEAL™ MS

Analyze both distribution information acquired using the iMScope QT and quantitative information obtained with the LCMS-9030 (ideal for quantification).

# Combined Analysis

Fusion of observations from an optical microscope with MS images  
(exclusive to Shimadzu)

MS images can be obtained flexibly and matched to observation images, either the entire image area or detailed portions of it.

## Measurement Results for the Cerebellum with 5 $\mu\text{m}$ Spatial Resolution

- Sample: mouse cerebellum
- Matrix: 9-AA
- Measurement region: 662  $\times$  595 (393,890 pixels)
- Measurement time: around 2.2 hours

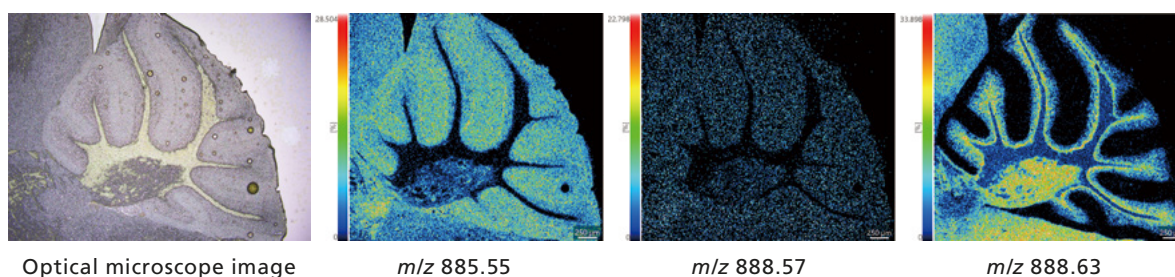

The region in the red frame below (cerebellum) was measured with a resolution of 5  $\mu\text{m}$ . High-resolution MS imaging and morphological observations with the optical microscope support cutting-edge research.

## Measurement Results for Whole Brain Sections in Negative Mode

- Sample: Whole mouse brain
- Matrix: 9-AA
- Measurement region: 1126  $\times$  624 (702,624 pixels)
- Measurement time: around 6 hours

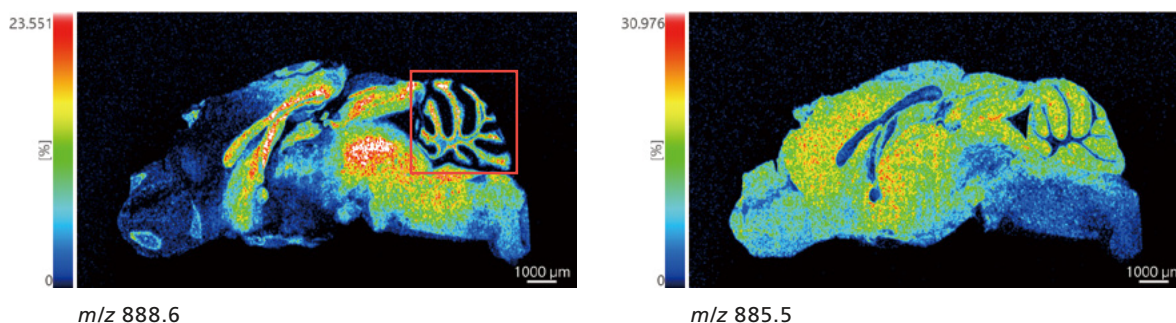

The sections of the mouse brain (17 mm  $\times$  9.4 mm) were measured at high resolution with a 15  $\mu\text{m}$  pitch (702,624 pixels). The high-resolution analysis of these large brain sections was completed in around 6 hours, enabling testing to proceed efficiently.

# Quantification and Distribution

Obtain qualitative and quantitative information from LC-MS as well as position information from mass spectrometry imaging (MSI) with a single instrument.

The combined system, which can perform LC-MS analysis in addition to MSI analysis, provides both distribution information and quantitative analysis.

## Use as an MSI System

Sections of mouse tissue administered with chlorpromazine were measured with the iMScope QT. The distribution of unaltered chlorpromazine including differences in abundance could be visualized without the need for labeling.

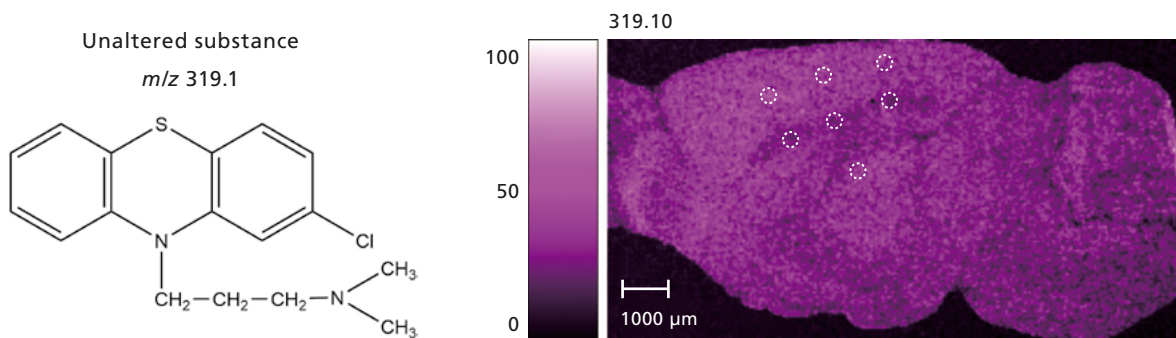

## Use as an LC-MS System

From the consecutive sections, the positions circled in the figure above were excised using laser micro dissection (LMD), and the extracted liquid was measured with the LCMS-9030.

The results below show a quantitative analysis of the concentration of chlorpromazine in the extracted liquid, carried out with LabSolutions Insight™. In this way, concentration differences of the pharmaceutical agent in the tissue sections indicated by MSI could be confirmed from the quantitative results determined using LC-MS.

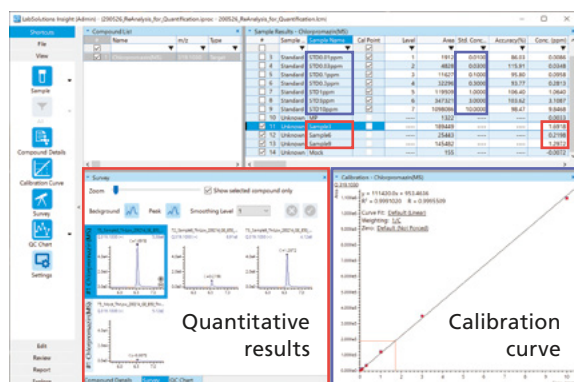

LabSolutions Insight Explore

In addition, it is possible to estimate the molecular formula of an unknown compound using the LabSolutions Insight Explore™ composition estimation function.

In this case, when the peak at  $m/z = 319.10$  determined using MSI was analyzed using the composition estimation function, the molecular formula for the unaltered chlorpromazine substance ( $C_{17}H_{19}N_2SCl$ ) was indicated as the most likely with the highest score.

| Ion Types          | Theoretical Value | Measured Value | Difference (mDa) |
|--------------------|-------------------|----------------|------------------|
| [M+H] <sup>+</sup> | 319.10302         | 319.10317      | +0.15            |

Results: highest score of 98.99, Diff. 0.15 mDa (0.458 ppm),  $C_{17}H_{19}N_2SCl$

# High Resolution, Speed and Accuracy

Acquisition of accurate, high-speed, high-resolution MS images, together with efficient data analysis

Combination of the high-accuracy, high-speed LCMS-9030\* with high-resolution mass spectrometry imaging

## Revolutionary, High Performance Analysis System

After scanning with the built-in optical microscope, the sample plate is moved directly to the ionization position, and the imaging process begins.

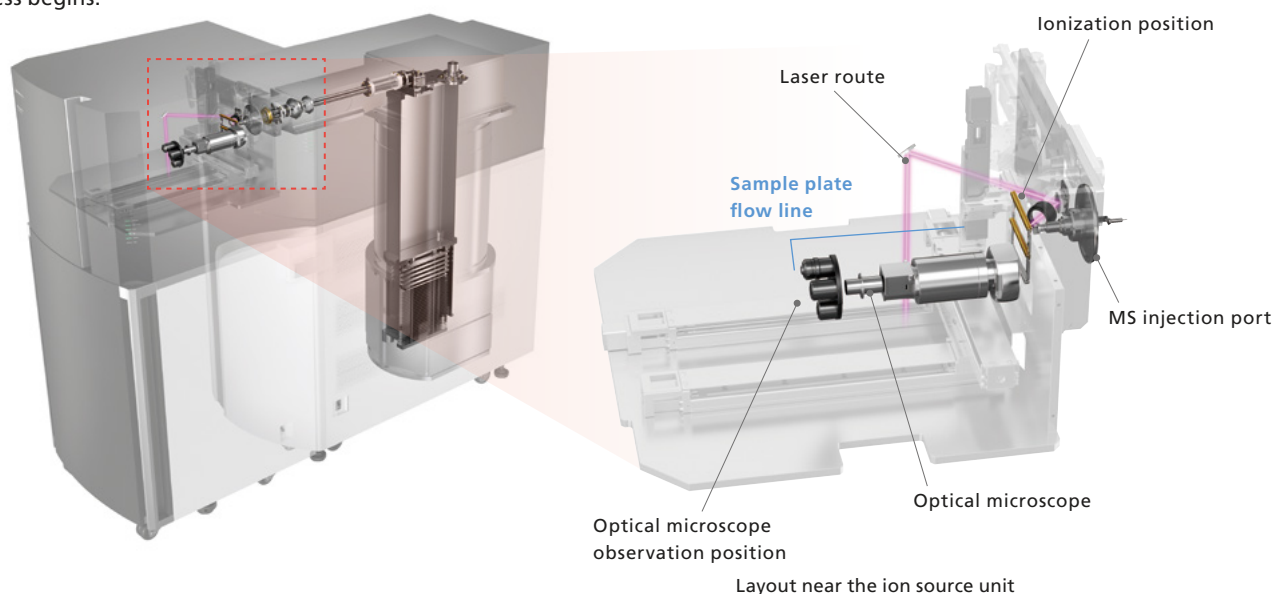

## Designed for Easy Attachment

The iMScope QT can be easily attached or detached from the LCMS-9030 to switch between mass spectrometry imaging and high-sensitivity LC-MS analysis.

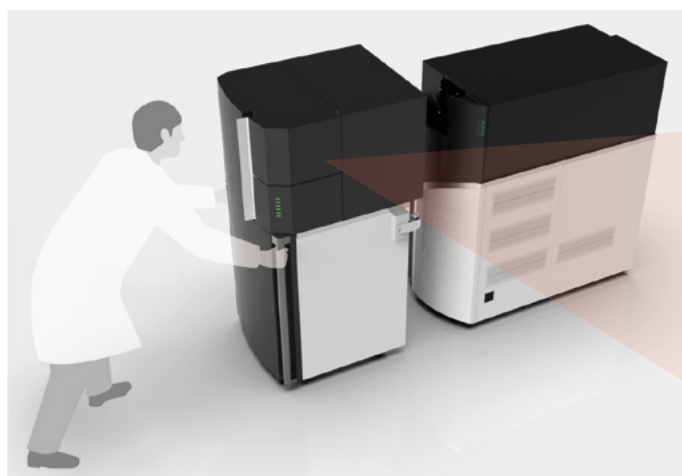

## User-Friendly Design



Easy sample setting

\* The LCMS-9030 is sold separately.



# Effortless Performance for Accurate Mass

## Excellence in Mass Measurement Accuracy (MMA)

Mass measurement accuracy (MMA) is the key performance attribute underlying all application fields using high-resolution accurate-mass (HRAM) spectrometers. The LCMS-9030 delivers the MMA needed for high-confidence identification of unknown compounds at an unprecedented level of stability.

This is made possible by new technologies implemented in the Intelligent Temperature Control System and the UF-FlightTube that accurately offset the changes occurring to both internal and external environments. With the LCMS-9030, Shimadzu aims to totally refashion the HRAM user experience, enabling scientists to run more samples at longer calibration intervals with greater confidence and ease.



Intelligent Temperature Control System (Patent pending)

## Stable MMA Against Temperature Fluctuation

Shimadzu's Intelligent Temperature Control System ensures stable MMA even in laboratory environments susceptible to temperature changes. To demonstrate, standards ranging from 150 to 1700 Da were analyzed continuously after a single calibration. Normal laboratory temperature fluctuation was observed between 25°C and 28°C.

Without additional mass correction, the measured accurate masses of all compounds remained within 1 ppm of the theoretical mass for the 60-hour duration of the experiment.

With the LCMS-9030, laboratory productivity can be increased by running long, calibration-free batches with confidence.

### Positive Mode

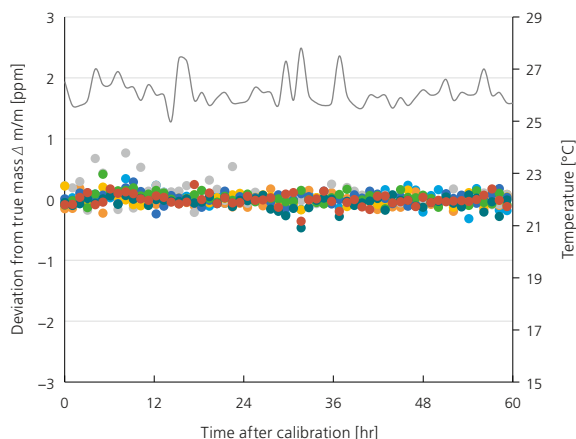

- Acetoaminophen
- Anisomycin
- Progesterone
- Mitomycin C
- Griseofulvin
- Doxorubicin
- Rifampicin
- Valinomycin
- Temperature

### Negative Mode

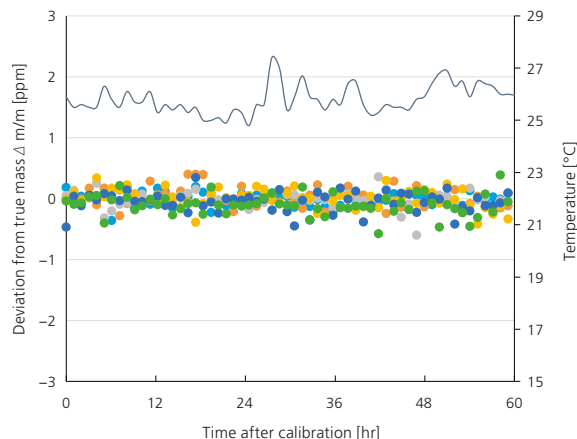

- Doxorubicin
- Salinomycin
- Thiostrepton
- Tubercidin
- Valinomycin
- Mitomycin C
- Temperature

# Pretreatment Instruments for MALDI Imaging

With mass spectrometry imaging (MSI), suitable pretreatment is important. High quality MSI analysis results are obtained from a combination of the spray method and the vapor deposition method.

## Work Flow

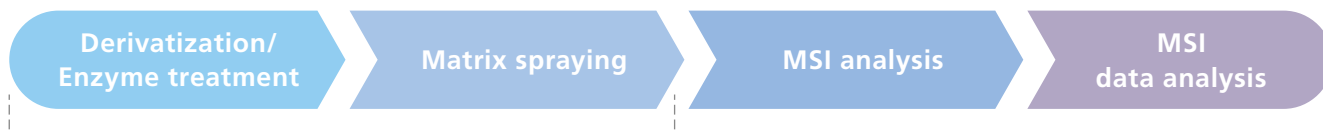

Automation of pretreatments conventionally requiring expertise

## Automatic Sprayer

### iMLayer AERO (Option)

The iMLayer AERO incorporates a sample stage that moves at a controlled rate while maintaining the same distance from the spray nozzle, enabling stable matrix spraying.

Over multiple strokes, the sample becomes laminated with fine matrix crystals, enabling high sensitivity and high spatial resolution.

#### Sample stage and Spray nozzle

The newly developed spray nozzle provides a fine spray. The distance between the sample and nozzle can be adjusted between 5 and 10 cm.



## Imaging with High Reproducibility

### • Humidity Control

Humidity does not impact matrix deposition because the atmosphere within the spray chamber is replaced before pretreatment. Spraying can be performed under more stable conditions than with a hand spray.



### • Clog-Free Reagent Delivery

If the matrix clogs the nozzle tip, the spray becomes unstable, which can lead to lower reproducibility. The rinsing mechanism allows for clog-free stable spraying which enables high reproducibility in MALDI analyses.

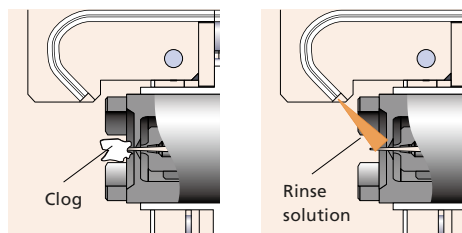

## Matrix Vapor Deposition System

# iMLayer (Option)

Applying the matrix by the vapor deposition method supports high resolution MALDI imaging.

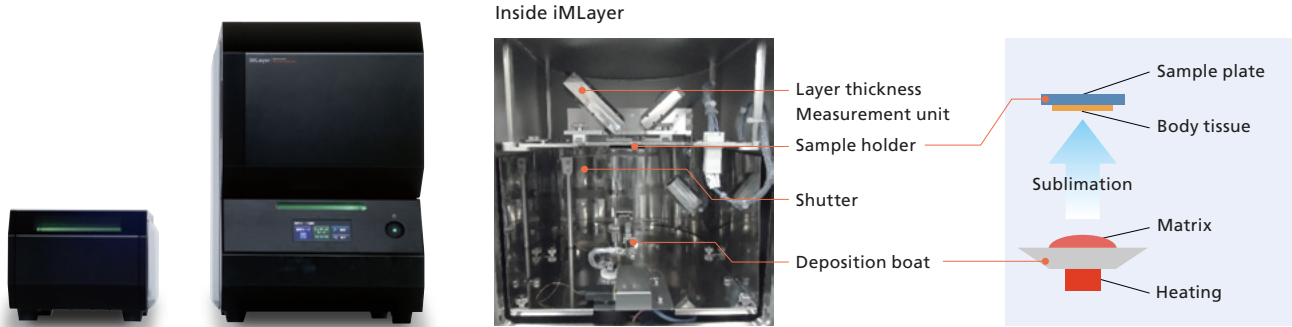

Applying fine matrix crystals by vapor deposition

### Both Spatial Resolution and Sensitivity Thanks to the Two-Step Vapor Deposition Method

#### • Two-Step Vapor Deposition

A two-step vapor deposition method has been developed\*, which provides high spatial resolution (5 to 10  $\mu\text{m}$ ) and high sensitivity, thanks to a combination of iMLayer (vapor deposition method) and iMLayer AERO (spray method). This unique experiment can only be implemented using Shimadzu sample preparation solutions.

\* Patent No.: JP6153139 and JP6183779

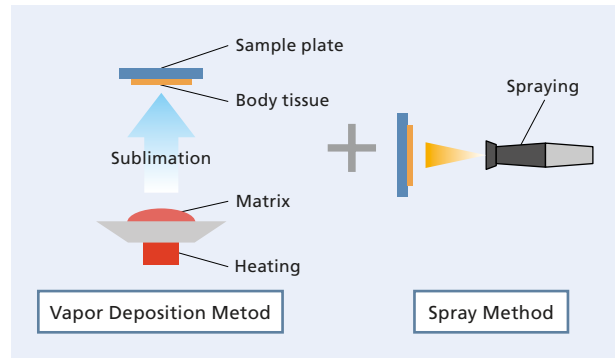

### Two-Step Vapor Deposition Allows for Very Fine Images with Minimal Blur

#### Hand Spray

- Matrix: 9-AA
- Volume used: 200  $\mu\text{L}$

#### Two-Step Vapor Deposition

1 step: iMLayer (vapor deposition method)

- Film thickness: 1  $\mu\text{m}$
- 2 step: iMLayer AERO (spray method)
- Solution delivery volume: 120  $\mu\text{L}/\text{min}$
- Stage speed: 70 mm/sec
- Laminating layers: 4

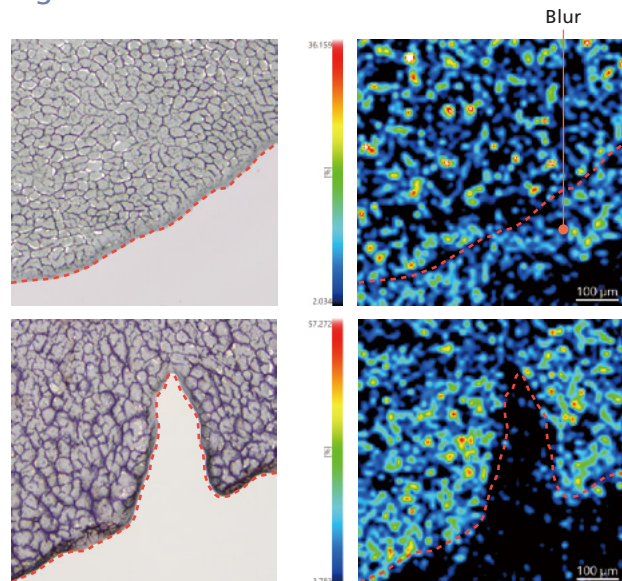

iMScope, iMLayer, LCMS, IMAGEREVEAL, LabSolutions Insight and LabSolutions Insight Explore are trademarks of Shimadzu Corporation.



Shimadzu Corporation  
[www.shimadzu.com/an/](http://www.shimadzu.com/an/)

**For Research Use Only. Not for use in diagnostic procedures.**

This publication may contain references to products that are not available in your country. Please contact us to check the availability of these products in your country.

Company names, products/service names and logos used in this publication are trademarks and trade names of Shimadzu Corporation, its subsidiaries or its affiliates, whether or not they are used with trademark symbol "TM" or "®".

Third-party trademarks and trade names may be used in this publication to refer to either the entities or their products/services, whether or not they are used with trademark symbol "TM" or "®".

Shimadzu disclaims any proprietary interest in trademarks and trade names other than its own.

The contents of this publication are provided to you "as is" without warranty of any kind, and are subject to change without notice. Shimadzu does not assume any responsibility or liability for any damage, whether direct or indirect, relating to the use of this publication.